

# Modulate Magnetic Kit 20-04

MOD-20-04-M

MOD-20-04-M-OCE

Modulate™ Fabric Banner kits feature unique angles and shapes, are portable and now are even easier to configure to achieve your dream space! Modulate now offers magnets to attach frames and keep them securely connected together. Choose from multiple frame shapes to design your own combinations – walls, booths, conference rooms, storage areas – the possibilities are endless! The aluminum tube frames feature snap-button and spigot connections that are coupled with a printed pillowcase fabric graphic that slips over the frame and zips closed at the bottom. Universal feet connect the tube frames at the bottom of the display. Each frame comes in a durable, portable carry bag.



## features and benefits:

- Magnetized premium aluminum tube frame with spigot and snap button assembly
- Easy to store and ship
- Quick to set up
- Weighted feet for added stability
- Comes with carry bag and box
- Zipper pillowcase fabric graphics
- Lifetime limited hardware warranty against manufacturer defects

## dimensions:

|   |  |
|---|--|
| Hardware  | Graphic  |
| <p>Assembled unit:<br/>226.26" w x 96" h x 51.97" d<br/>5747mm(w) x 2438mm(h) x 1320mm(d)</p> <p>Approximate weight:<br/>65 lb / 30 kg</p>  | <p>Refer to related graphic template for more information.</p> <p>Visit:<br/><a href="http://www.exhibitors-handbook.com/graphic-templates">www.exhibitors-handbook.com/graphic-templates</a></p>  |
| Shipping  | <b>additional information:</b>   |
| <p>Packing Option 1: <b>MOD-20-04-M</b></p> <p>2 Boxes: 48" l x 11" h x 4" d<br/>1219mm(l) x 279mm(h) x 102mm(d)</p> <p>3 Boxes: 60" l x 11" h x 4" d<br/>1524mm(l) x 279mm(h) x 102mm(d)</p> <p>Approximate shipping weight:<br/>75 lb / 34 kg</p> | <p>Graphic material:<br/>Dye-sublimation zipper pillowcase fabric</p> <p>When included in a larger kit, a different packaging solution will be listed to accommodate all contents of the kit. Individual packaging no longer provided.</p>   |
| <p>Packing Option 2: <b>MOD-20-04-M-OCE</b></p> <p>2 OCE: Expandable case length (l) may vary<br/>40" - 66" l x 18" h x 18" d<br/>1016mm-1677mm(l) x 458mm(h) x 458mm(d)</p> <p>Approximate shipping weight:<br/>157 lb / 72 kg</p>                 | <div data-bbox="1533 1070 2009 1289" data-label="Image"> </div> <p>Use caution when handling this product around mechanical wrist watches, metal tools, electronic devices, credit cards or any other similar items. DO NOT place any part of the body, such as fingers, hands, etc, between the magnetic surface areas of the components.</p> |

We are continually improving and modifying our product range and reserve the right to vary the specifications without prior notice. All dimensions and weights quoted are approximate and we accept no responsibility for variance. E&OE. See Graphic Templates for graphic bleed specifications.

# Included In Your Kit



MOD-FRM-01-M x1



MOD-FRM-02-M x1



MOD-FRM-09-M x1



MOD-FRM-10-M x2

|                              |  |
|------------------------------|--|
|                              | <b>CAUTION</b><br>Interaction with metallic objects may cause Pinch Hazards.     |
|                              | Persons with medical implants be advised magnets may interfere with your device. |
| <b>Strong Magnetic Field</b> |  |

Use caution when handling this product around mechanical wrist watches, metal tools, electronic devices, credit cards or any other similar items. DO NOT place any part of the body, such as fingers, hands, etc, between the magnetic surface areas of the components.

# Suggested Kit Layout

MOD-20-04-M

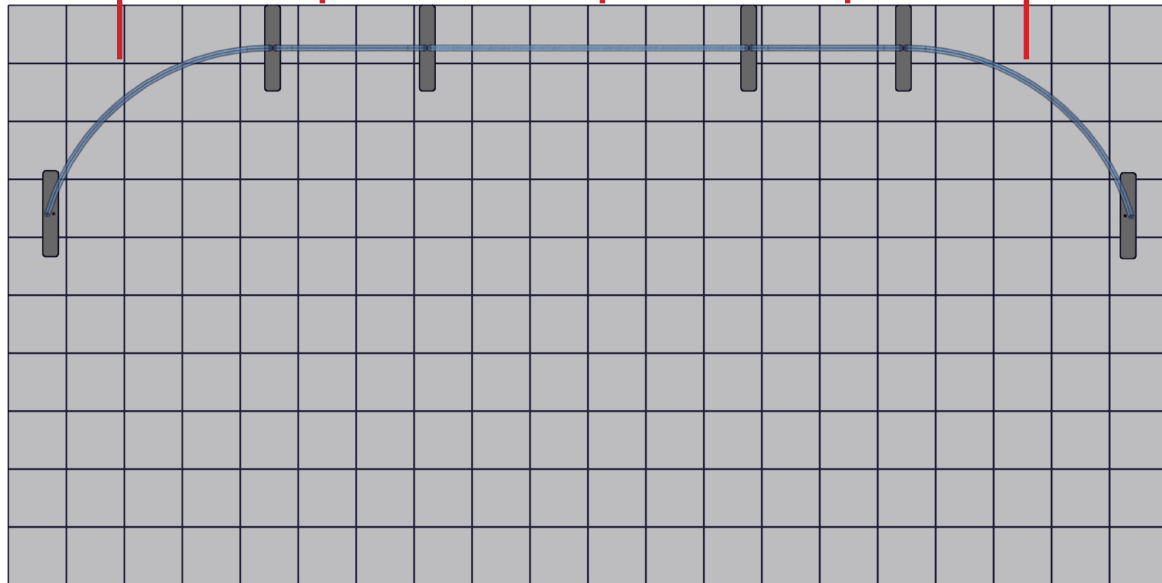
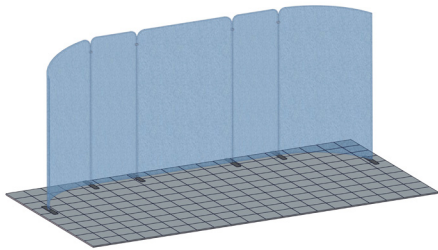
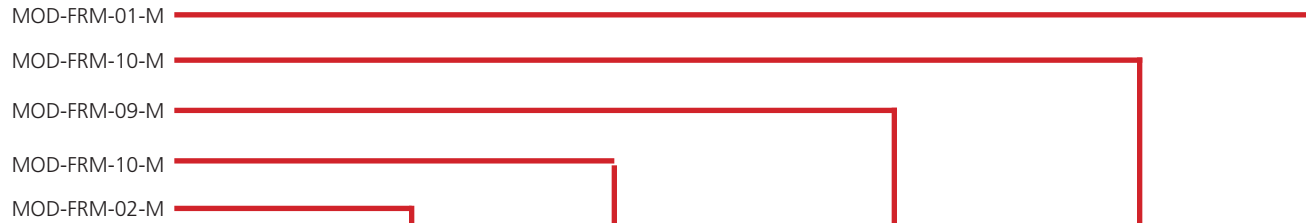

|                                     |   |
|-------------------------------------|---|
|                                     | <p><b>CAUTION</b></p> <p>Interaction with metallic objects may cause Pinch Hazards.</p> <p>Persons with medical implants be advised magnets may interfere with your device.</p> |
| <p><b>Strong Magnetic Field</b></p> |   |

Use caution when handling this product around mechanical wrist watches, metal tools, electronic devices, credit cards or any other similar items. DO NOT place any part of the body, such as fingers, hands, etc, between the magnetic surface areas of the components.

# Modulate Frame 01

## MOD-FRM-01-M

Modulate™ Fabric Banners feature unique angles and shapes, are portable and now are even easier to configure to achieve your dream space! Modulate now offers magnets to attach frames and keep them securely connected together. Choose from multiple frame shapes to design your own combinations – walls, booths, conference rooms, storage areas – the possibilities are endless! The aluminum tube frames feature snap-button and spigot connections that are coupled with a printed pillowcase fabric graphic that slips over the frame and zips closed at the bottom. Universal feet connect the tube frames at the bottom of the display. Each frame comes in a durable, portable carry bag.

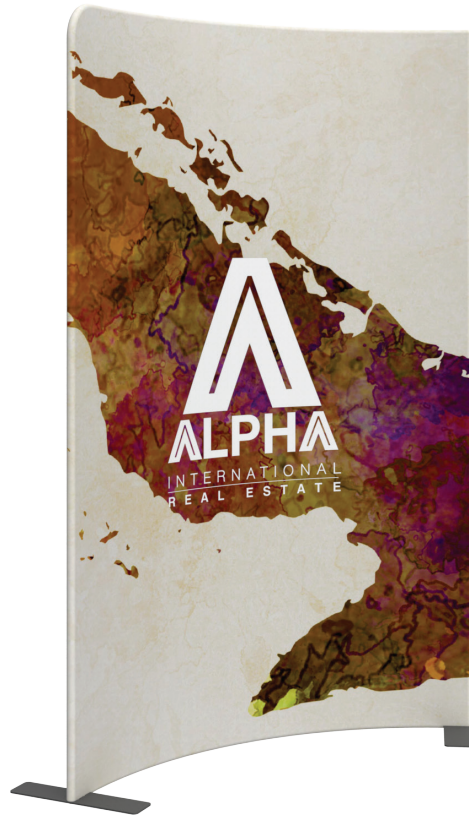

## features and benefits:

- Magnetized premium aluminum tube frame with spigot and snap button assembly
- Easy to store and ship
- Quick to set up
- Weighted feet for added stability
- Comes with carry bag and box
- Zipper pillowcase fabric graphics
- Lifetime limited hardware warranty against manufacturer defects

## dimensions:

|  |  |
|--|--|
| Hardware   | Graphic  |
| Assembled unit:<br>60" w x 96" h x 19" d<br>1523mm(w) x 2438mm(h) x 484mm(d) | Refer to related graphic template for more information.  |
| Approximate weight:<br>15 lb / 7 kg  | Visit:<br><a href="http://www.exhibitors-handbook.com/graphic-templates">www.exhibitors-handbook.com/graphic-templates</a> |

## Shipping

Packing box(es):  
1 Box

Box size: 60" l x 11" h x 4" d  
1524mm(l) x 279mm(h) x 102mm(d)

Approximate shipping weight:  
17 lb / 8 kg

## additional information:

Graphic material:  
Dye-sublimation zipper pillowcase fabric

When included in a larger kit, a different packaging solution will be listed to accommodate all contents of the kit. Individual packaging no longer provided.

|                              |   |
|------------------------------|---|
|                              | <b>CAUTION</b>  |
|                              | <p>Interaction with metallic objects may cause Pinch Hazards.</p> <p>Persons with medical implants be advised magnets may interfere with your device.</p> |
| <b>Strong Magnetic Field</b> |   |

Use caution when handling this product around mechanical wrist watches, metal tools, electronic devices, credit cards or any other similar items. DO NOT place any part of the body, such as fingers, hands, etc, between the magnetic surface areas of the components.

We are continually improving and modifying our product range and reserve the right to vary the specifications without prior notice. All dimensions and weights quoted are approximate and we accept no responsibility for variance. E&OE. See Graphic Templates for graphic bleed specifications.

# Included In Your Kit

Tools, Components, Connectors, Tubes & Graphics



HEX KEY SET x1

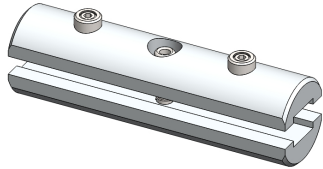

ES30 x4

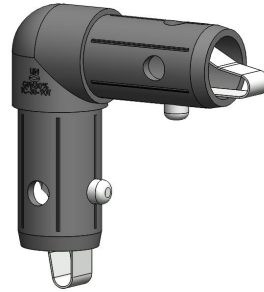

TC-30-90T x1

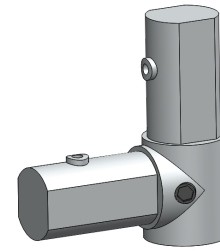

ES30-90B x2



PLT-BP-LN114-S5-450 x2

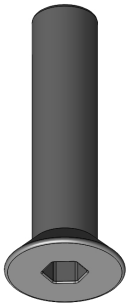

LN114-SCRW x2



MOD-FRM-01-T1 x1



MOD-FRM-01-T4 x1



MOD-FRM-01-T5 x1



MOD-FRM-01-T2-M-T x1



MOD-FRM-01-T2-M-B x2



MOD-FRM-01-T3-M-T x1

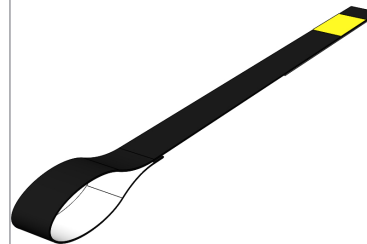

TUBE-STRAP-30-M x2

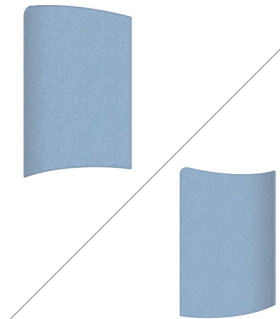

MOD-FRM-01-CC-LT-G x1  
MOD-FRM-01-CV-LT-G x1

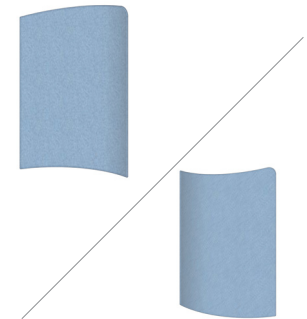



MOD-FRM-01-CC-RT-G x1  
MOD-FRM-01-CV-RT-G x1

# Exploded View

MOD-FRM-01-M

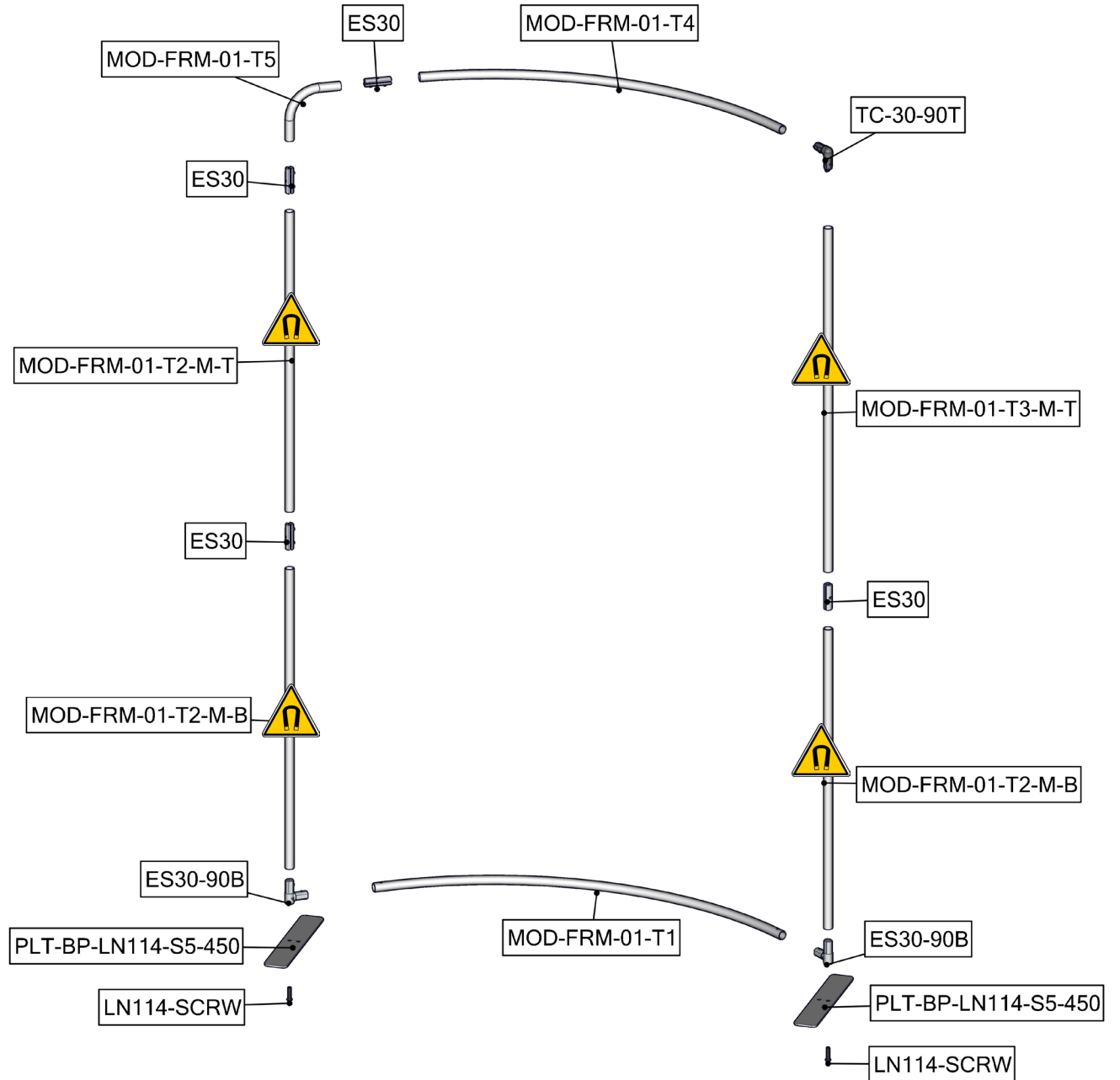
To assemble with curve left



|   |  |
|---|--|
|  | <b>CAUTION</b><br>Interaction with metallic objects may cause Pinch Hazards.<br>Persons with medical implants be advised magnets may interfere with your device. |
| <b>Strong Magnetic Field</b>  |  |

Use caution when handling this product around mechanical wrist watches, metal tools, electronic devices, credit cards or any other similar items. DO NOT place any part of the body, such as fingers, hands, etc, between the magnetic surface areas of the components.

# Exploded View

MOD-FRM-01-M

To assemble with curve right

|   |  |
|---|--|
|  | <b>CAUTION</b><br>Interaction with metallic objects may cause Pinch Hazards.     |
|   | Persons with medical implants be advised magnets may interfere with your device. |
| <b>Strong Magnetic Field</b>  |  |

Use caution when handling this product around mechanical wrist watches, metal tools, electronic devices, credit cards or any other similar items. DO NOT place any part of the body, such as fingers, hands, etc, between the magnetic surface areas of the components.

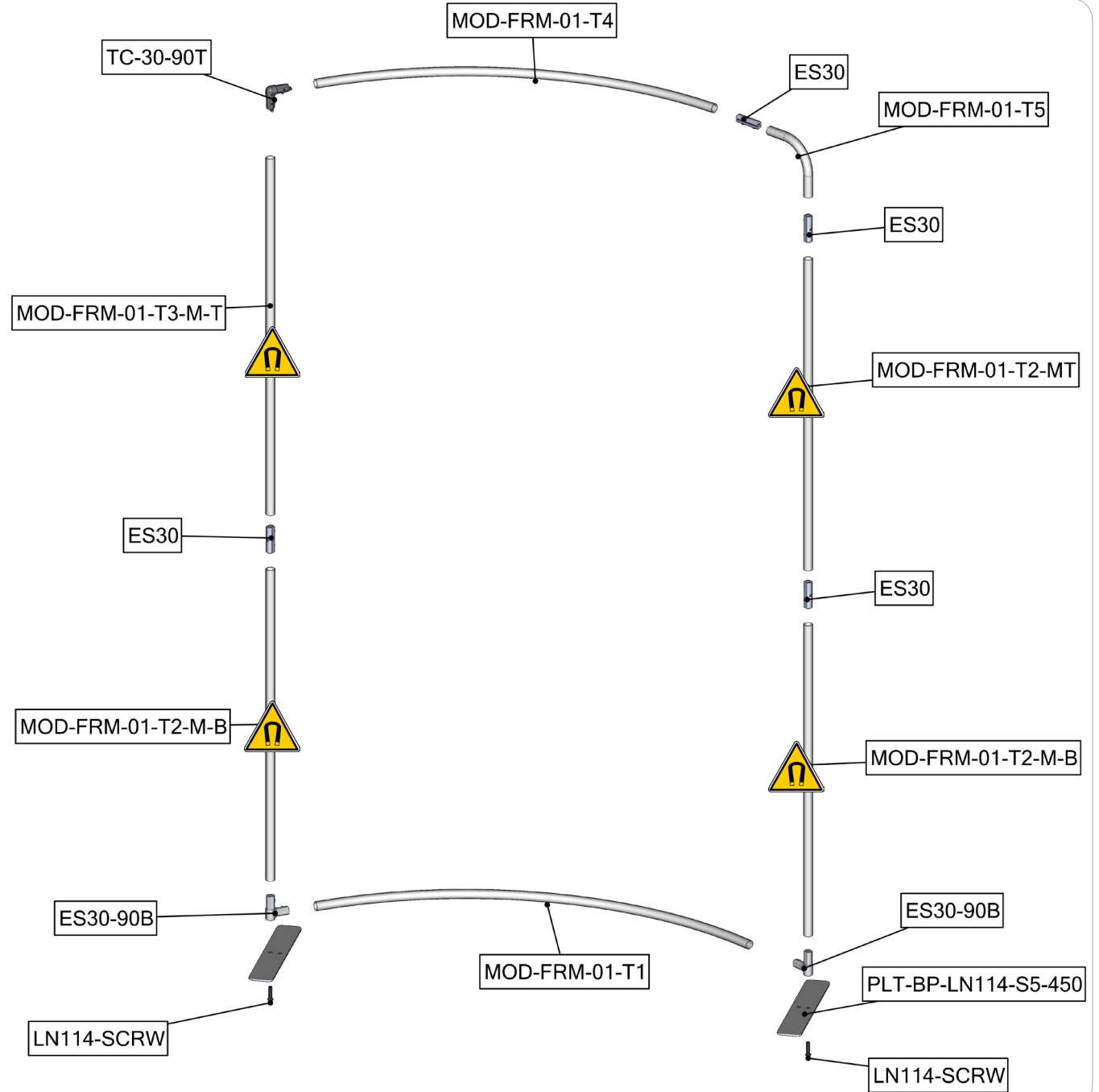

# Labeling Diagram

MOD-FRM-01-M

To assemble with curve left

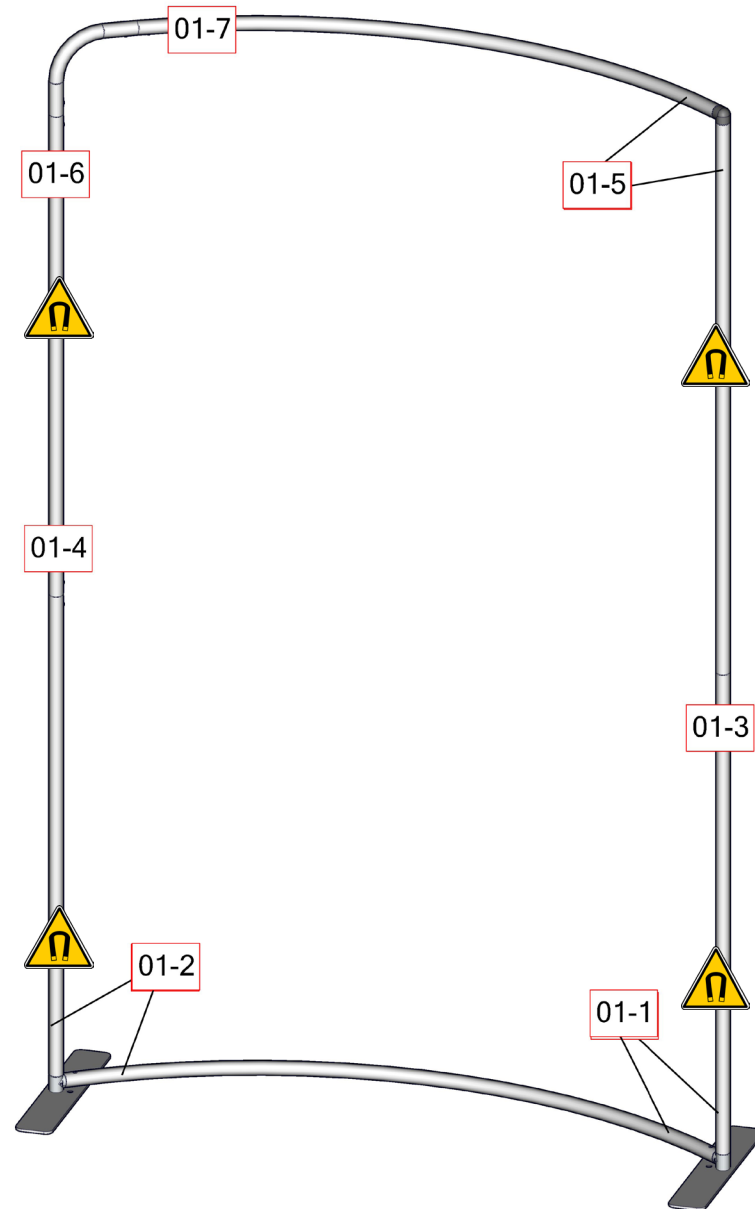

|   |  |
|---|--|
|  | <b>CAUTION</b>   |
|   | Interaction with metallic objects may cause Pinch Hazards.<br>Persons with medical implants be advised magnets may interfere with your device. |
| <b>Strong Magnetic Field</b>  |  |

Use caution when handling this product around mechanical wrist watches, metal tools, electronic devices, credit cards or any other similar items. DO NOT place any part of the body, such as fingers, hands, etc, between the magnetic surface areas of the components.



# Labeling Diagram

MOD-FRM-01-M

To assemble with curve right

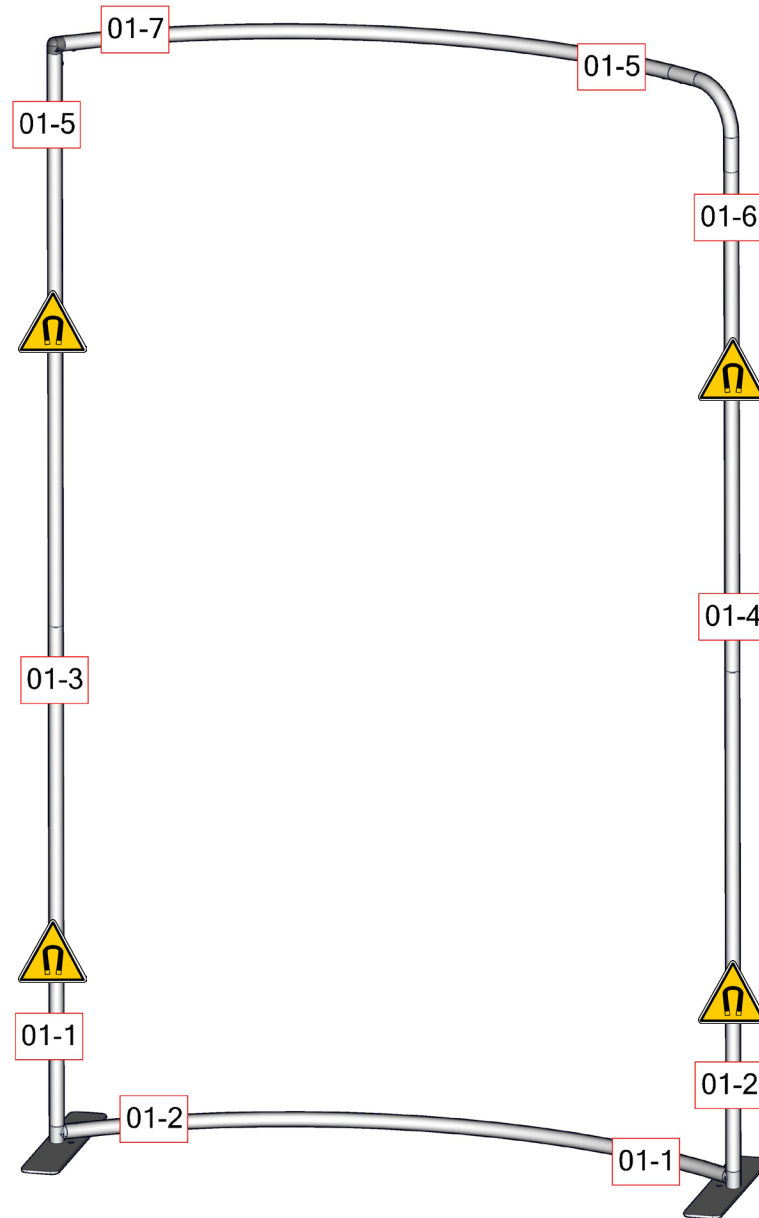

|                              |  |
|------------------------------|--|
|                              | <b>CAUTION</b><br>Interaction with metallic objects may cause Pinch Hazards.<br>Persons with medical implants be advised magnets may interfere with your device. |
| <b>Strong Magnetic Field</b> |  |

Use caution when handling this product around mechanical wrist watches, metal tools, electronic devices, credit cards or any other similar items. DO NOT place any part of the body, such as fingers, hands, etc, between the magnetic surface areas of the components.

# Connection Methods

Connection Method 1: ES30

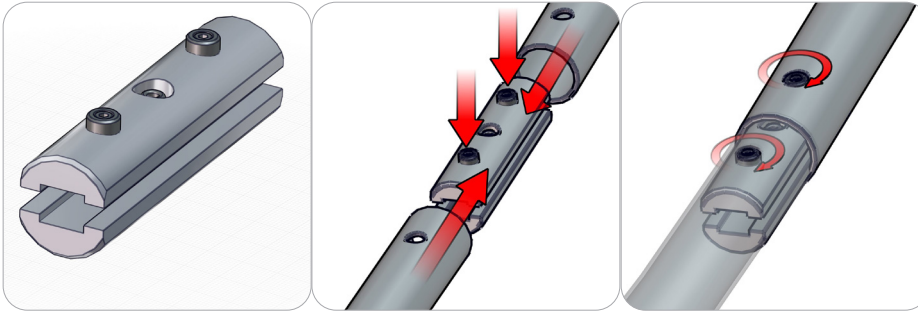

For spigot connections, compress the unlocked connector and slide into the tube lock access hole. Lock both screws carefully using your allen key tool. Be sure to lock securely, but do not over tighten. Do not force the connection and be careful with the tube edges, they may be sharp. To disassemble, unlocked connector press the snap button and pull apart.

Connection Method 2: TC-30-90T

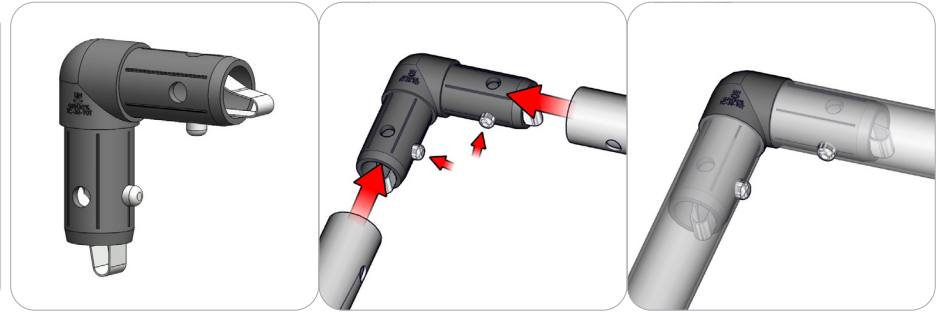

Take the plastic connector and make sure the snap buttons are in proper position for the frame tube holes. Simply press the snap button with your thumb and carefully slide the tube onto the connector. The snap button should pop through. Some twisting may be necessary to assure the snap button has popped all the way through the tube hole. Do not force the connection and be careful with the tube edges, they may be sharp.

Connection Method 3: ES30-90B

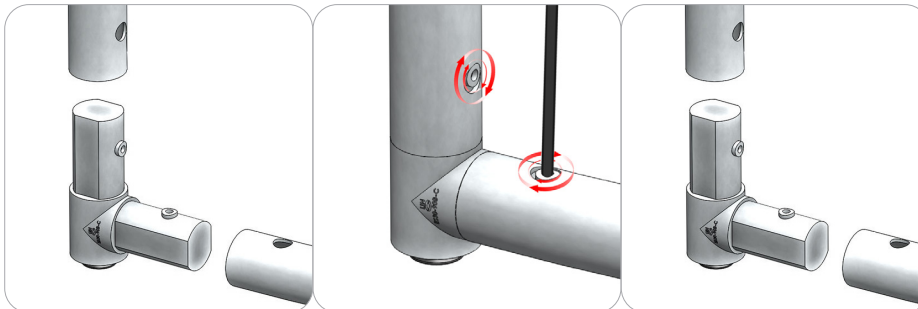

Compress one unlocked end of the connector and slide it through one tube end. Compress the other end of the connector and slide the second tube on. Lock both screws carefully using your allen key tool. Be sure to lock securely, but do not over tighten.

Connection Method 4: TUBE-STRAP

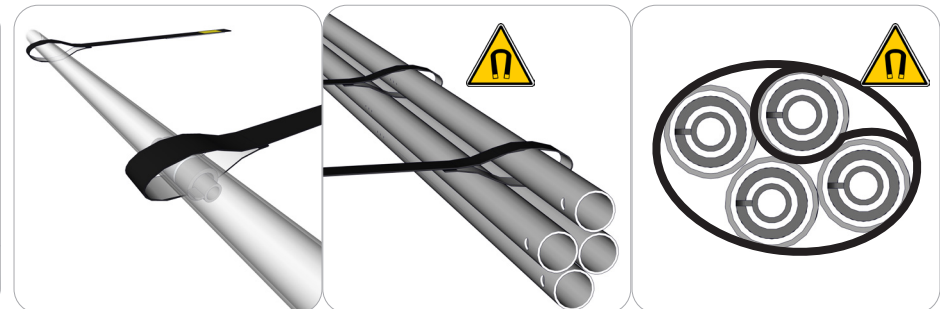

The velcro tube straps add safety when handling the magnetized tubes before, during and after display setup. Follow these steps to bundle the magnetized tubes. First, place 1 tube into 2 strap pockets. Then, place the strap pockets over the labeled magnetized area on the tube. Next, firmly hold the tube and bundle the rest of the magnetized tubes together. The straps hold up to 4 tubes to make 1 bundle. Finally, take the hook velcro and wrap it around the tubes for a secure hold.



Use caution when handling this product around mechanical wrist watches, metal tools, electronic devices, credit cards or any other similar items. DO NOT place any part of the body, such as fingers, hands, etc, between the magnetic surface areas of the components.

# Connection Methods

## Connection Method 5: PLT-BP-LN114-S5

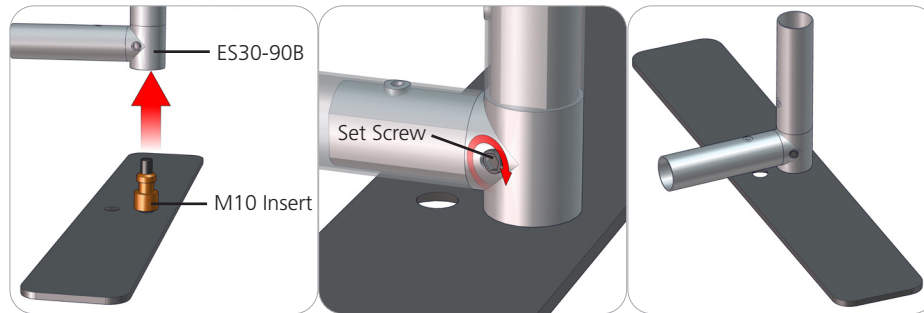

First, loosen the set screw that is on the ES30-90B, then attach the base plate with the M10 insert. Once the base plate is in the desired position, fasten the set screw to hold the insert in place.

## Connection Method 6: PLT-BP-LN114-S5

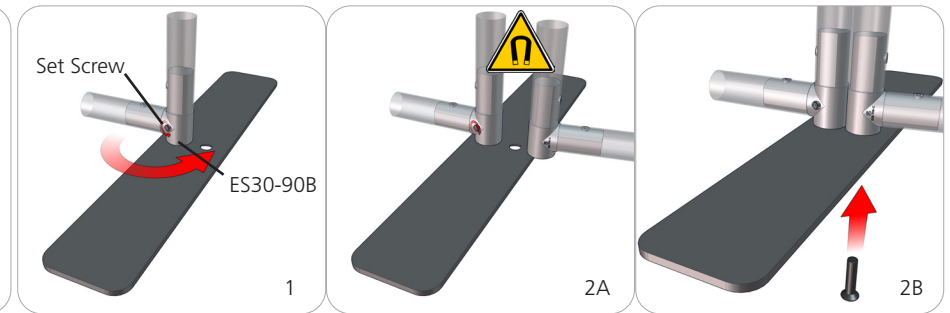

There are two ways you can connect individual frames to make a back wall unit. (1A) The first thing to do is to loosen the set screw that is on the ES30-90B. Do not remove the set screw. Next, rotate the stabilizing base hole to the outside of the frame and tighten the set screw.



(2A) Connecting magnet frames together is easy - the frames will simply magnetize to each other. Use caution when handling the magnetized frames. The frame will rest on the stabilizing base, covering the hole leaving a leveled finished look.

(2B) When your frame does not feature magnets, you will have to use the provided ES30-90B set screw to fasten it onto the base. Don't forget to use your frame clip at the top to level the panels.

# Kit Assembly

## Step by Step

### Step 1.

Gather the components to build the frame. Use the Exploded View and the Labeling Diagram for part labels.

Reference Connection Method(s) 1, 2, 3 and 4 for more details.

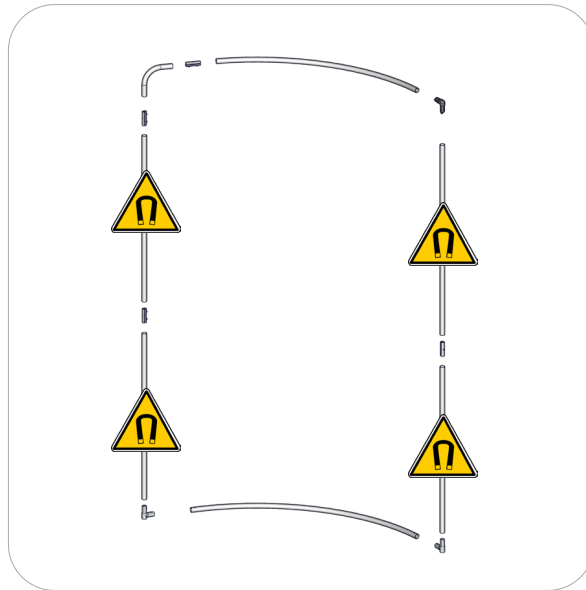

### Step 2.

Locate your pillowcase graphic. With the pillowcase unzipped, encase the frame by covering the frame from top to bottom. Zipper at the bottom.

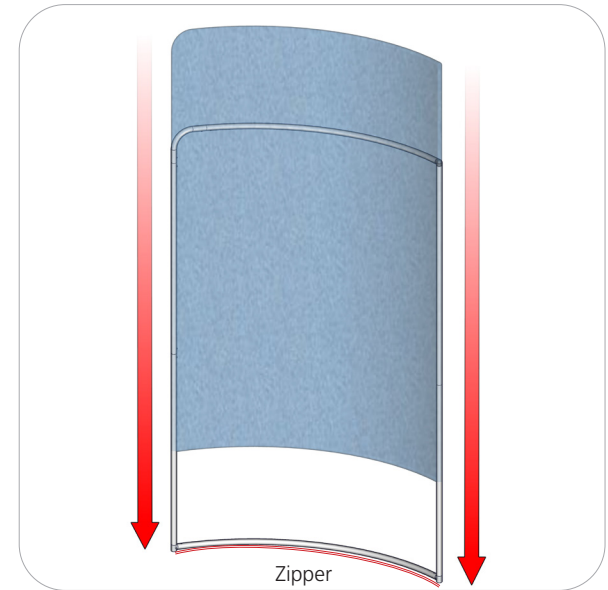
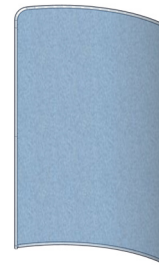

### Step 3.

Locate the stabilizing bases. Attach each foot to the bottom ends of the frame. Use the allen key tool provided to lock the bases in place.

Reference Connection Method(s) 5 for more details.

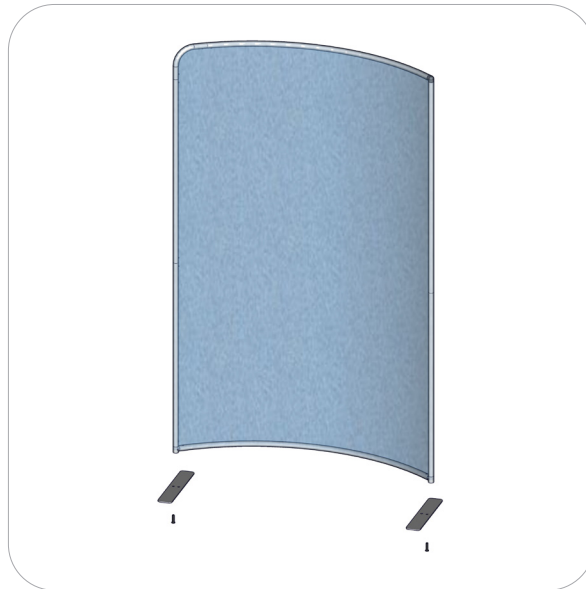

### Step 4.

Setup is complete.

If you are connecting frames side by side, reference Connection Method(s) 6 for more details.

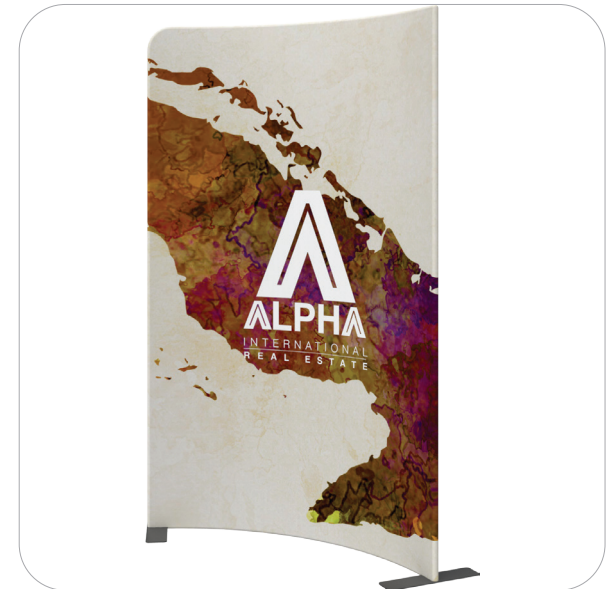

# Modulate Frame 02

## MOD-FRM-02-M

Modulate™ Fabric Banners feature unique angles and shapes, are portable and now are even easier to configure to achieve your dream space! Modulate now offers magnets to attach frames and keep them securely connected together. Choose from multiple frame shapes to design your own combinations – walls, booths, conference rooms, storage areas – the possibilities are endless! The aluminum tube frames feature snap-button and spigot connections that are coupled with a printed pillowcase fabric graphic that slips over the frame and zips closed at the bottom. Universal feet connect the tube frames at the bottom of the display. Each frame comes in a durable, portable carry bag.



## features and benefits:

- Magnetized premium aluminum tube frame with spigot and snap button assembly
- Easy to store and ship
- Quick to set up
- Weighted feet for added stability
- Comes with carry bag and box
- Zipper pillowcase fabric graphics
- Lifetime limited hardware warranty against manufacturer defects

## dimensions:

|  |  |
|--|--|
| Hardware   | Graphic  |
| Assembled unit:<br>60" w x 96" h x 19.3" d<br>1523mm(w) x 2438mm(h) x 490mm(d) | Refer to related graphic template for more information.  |
| Approximate weight:<br>15 lb / 7 kg  | Visit:<br><a href="http://www.exhibitors-handbook.com/graphic-templates">www.exhibitors-handbook.com/graphic-templates</a> |

## Shipping

Packing box(es):  
1 Box

Box size: 60" l x 11" h x 4" d  
1524mm(l) x 279mm(h) x 102mm(d)

Approximate shipping weight:  
17 lb / 8 kg

## additional information:

Graphic material:  
Dye-sublimation zipper pillowcase fabric

When included in a larger kit, a different packaging solution will be listed to accommodate all contents of the kit. Individual packaging no longer provided.

|   |  |
|---|--|
|  | <b>CAUTION</b><br>Interaction with metallic objects may cause Pinch Hazards.     |
|   | Persons with medical implants be advised magnets may interfere with your device. |
| <b>Strong Magnetic Field</b>  |  |

Use caution when handling this product around mechanical wrist watches, metal tools, electronic devices, credit cards or any other similar items. DO NOT place any part of the body, such as fingers, hands, etc, between the magnetic surface areas of the components.

We are continually improving and modifying our product range and reserve the right to vary the specifications without prior notice. All dimensions and weights quoted are approximate and we accept no responsibility for variance. E&OE. See Graphic Templates for graphic bleed specifications.

# Included In Your Kit

Tools, Components, Connectors, Tubes & Graphics



HEX KEY SET x1

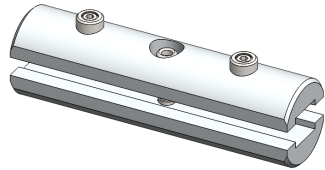

ES30 x4

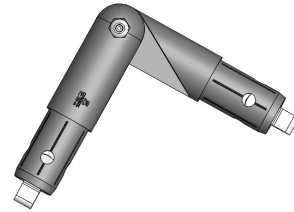

TC-30-A x1

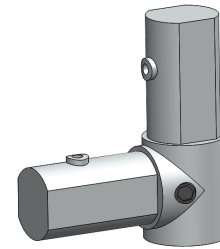

ES30-90B x2



PLT-BP-LN114-S5-450 x2

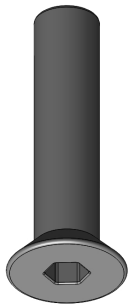

LN114-SCRW x2



MOD-FRM-02-T1 x1



MOD-FRM-02-T3 x1



MOD-FRM-02-T4 x1



MOD-FRM-02-T2-M-T x1



MOD-FRM-02-T2-M-B x2



MOD-FRM-02-T5-M-T x1

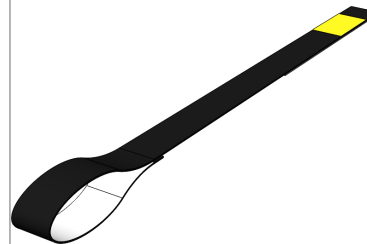

TUBE-STRAP-30-M x2

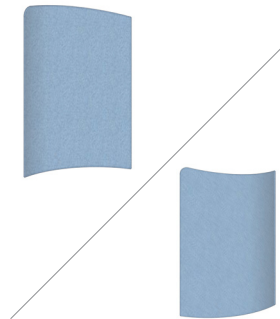

MOD-FRM-02-CC-LT-G x1  
MOD-FRM-02-CV-LT-G x1

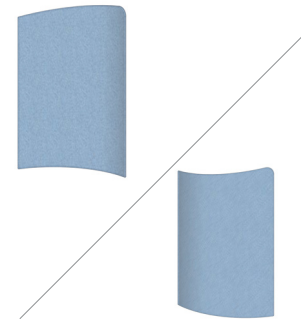

MOD-FRM-02-CC-RT-G x1  
MOD-FRM-02-CV-RT-G x1

# Exploded View

MOD-FRM-02-M

To assemble with curve left

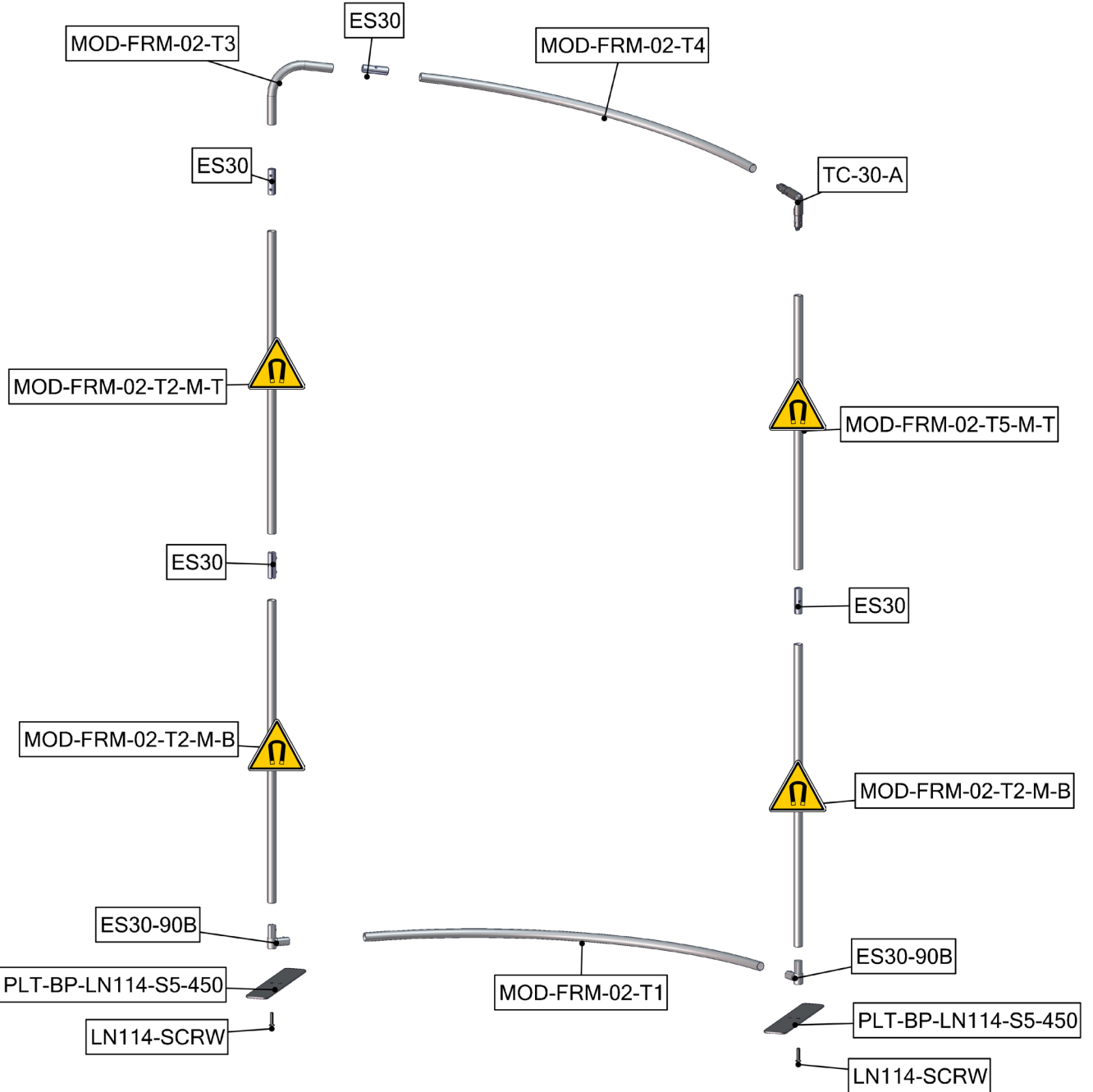

|                              |   |
|------------------------------|---|
|                              | <b>CAUTION</b>  |
|                              | <p>Interaction with metallic objects may cause Pinch Hazards.</p> <p>Persons with medical implants be advised magnets may interfere with your device.</p> |
| <b>Strong Magnetic Field</b> |   |

Use caution when handling this product around mechanical wrist watches, metal tools, electronic devices, credit cards or any other similar items. DO NOT place any part of the body, such as fingers, hands, etc, between the magnetic surface areas of the components.

# Exploded View

MOD-FRM-02-M

To assemble with curve right

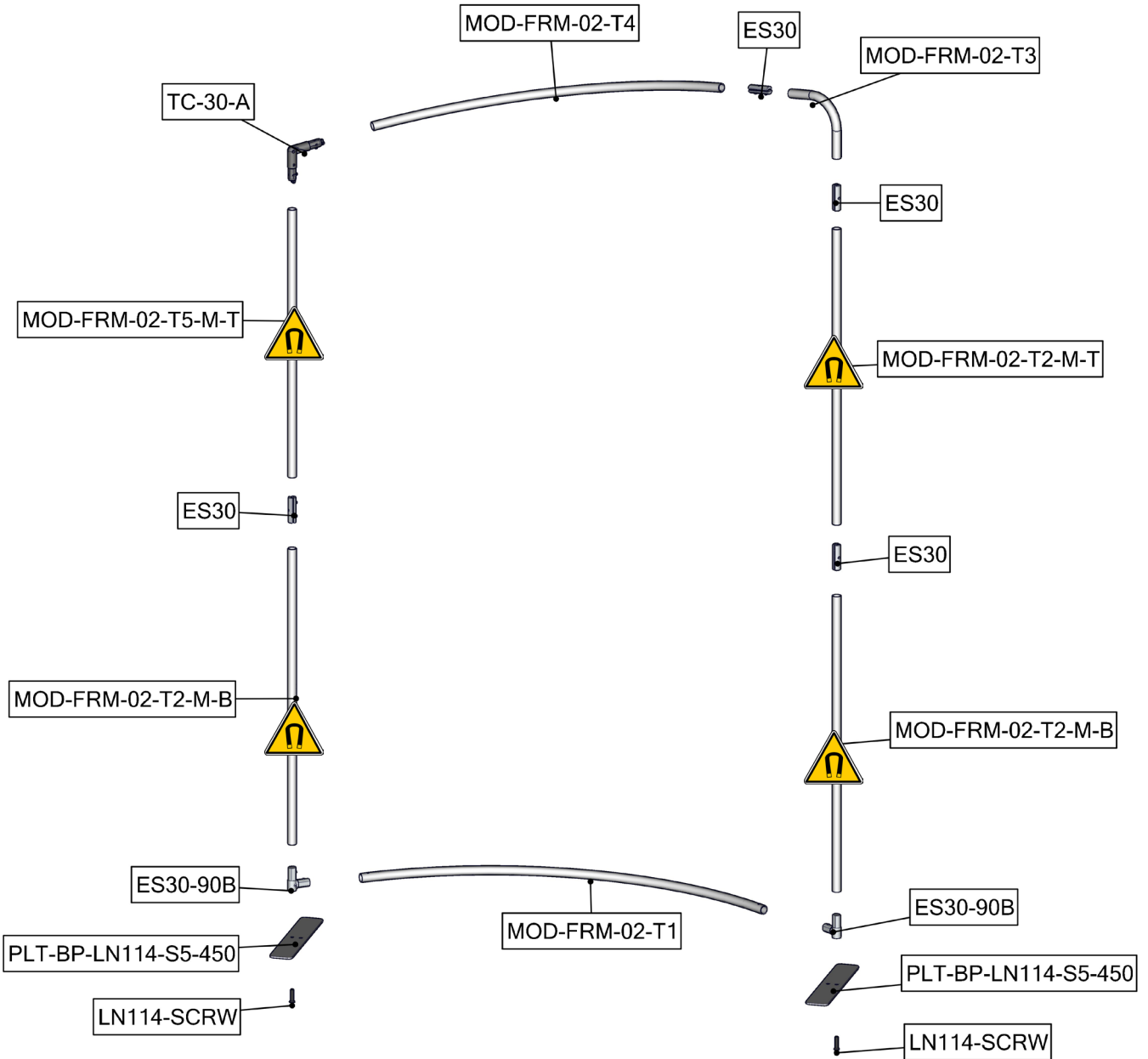

|                                     |   |
|-------------------------------------|---|
|                                     | <b>CAUTION</b>  |
|                                     | <p>Interaction with metallic objects may cause Pinch Hazards.</p> <p>Persons with medical implants be advised magnets may interfere with your device.</p> |
| <p><b>Strong Magnetic Field</b></p> |   |

Use caution when handling this product around mechanical wrist watches, metal tools, electronic devices, credit cards or any other similar items. DO NOT place any part of the body, such as fingers, hands, etc, between the magnetic surface areas of the components.



# Labeling Diagram

MOD-FRM-02-M

To assemble with curve left

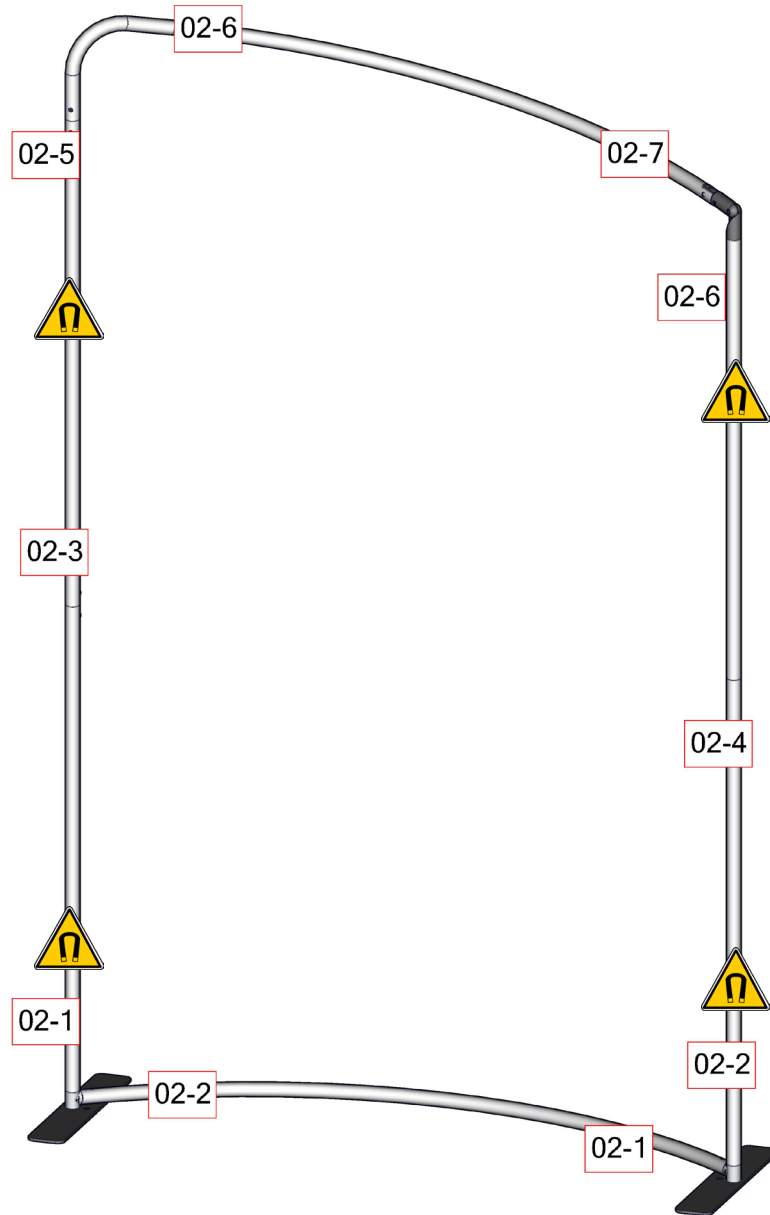

|   |  |
|---|--|
|  | <b>CAUTION</b><br>Interaction with metallic objects may cause Pinch Hazards.<br>Persons with medical implants be advised magnets may interfere with your device. |
| <b>Strong Magnetic Field</b>  |  |

Use caution when handling this product around mechanical wrist watches, metal tools, electronic devices, credit cards or any other similar items. DO NOT place any part of the body, such as fingers, hands, etc, between the magnetic surface areas of the components.

# Labeling Diagram

MOD-FRM-02-M

To assemble with curve right

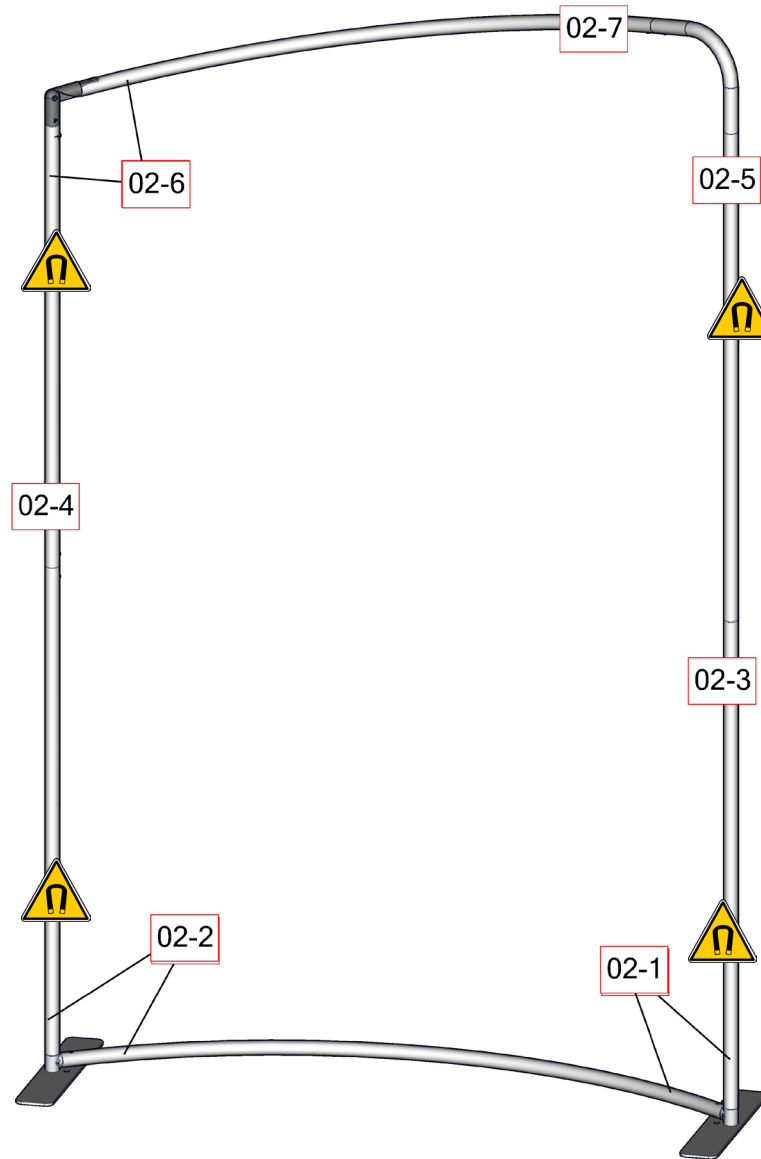

|                              |  |
|------------------------------|--|
|                              | <b>CAUTION</b><br>Interaction with metallic objects may cause Pinch Hazards.<br>Persons with medical implants be advised magnets may interfere with your device. |
| <b>Strong Magnetic Field</b> |  |

Use caution when handling this product around mechanical wrist watches, metal tools, electronic devices, credit cards or any other similar items. DO NOT place any part of the body, such as fingers, hands, etc, between the magnetic surface areas of the components.

# Connection Methods

## Connection Method 1: ES30

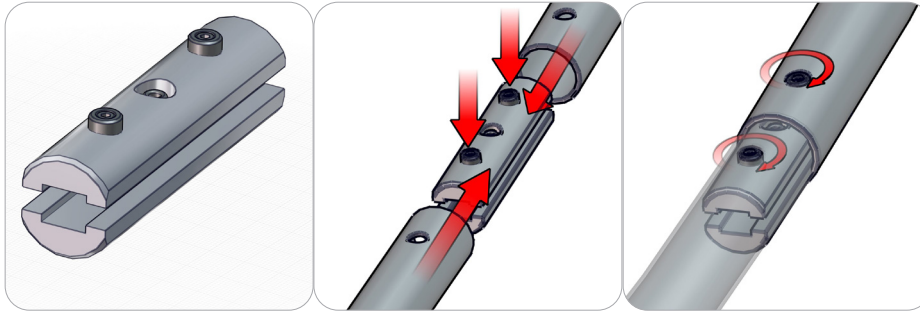

For spigot connections, compress the unlocked connector and slide into the tube lock access hole. Lock both screws carefully using your allen key tool. Be sure to lock securely, but do not over tighten. Do not force the connection and be careful with the tube edges, they may be sharp. To disassemble, unlocked connector press the snap button and pull apart.

## Connection Method 2: TC-30-A

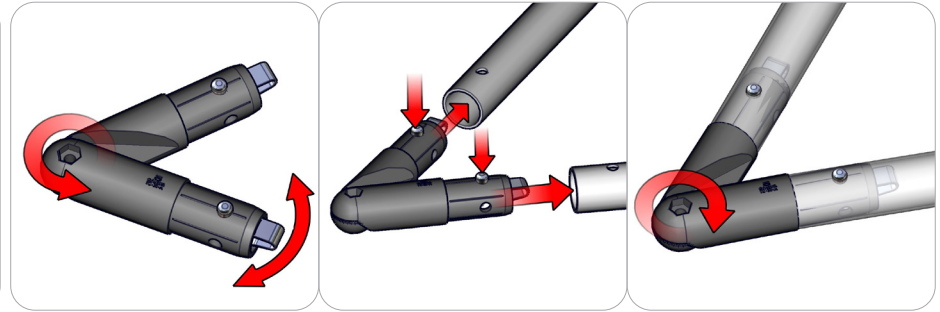

If needed, use the provided hex key tool to loosen the corner screw for adjusting the angle of the connector to fit your frame. Next, take the plastic connector and make sure the snap buttons are in proper position for the frame tube holes. Simply press the snap button with your thumb and carefully slide the tube onto the connector. The snap button should pop through. Some twisting may be necessary to assure the snap button has popped all the way through the tube hole. Do not force the connection and be careful with the tube edges, they may be sharp. You can tighten the corner screw to hold its shape.

## Connection Method 3: ES30-90B

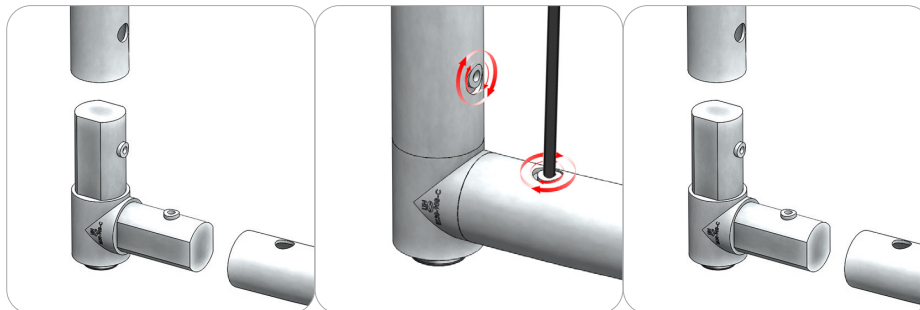

Compress one unlocked end of the connector and slide it through one tube end. Compress the other end of the connector and slide the second tube on. Lock both screws carefully using your allen key tool. Be sure to lock securely, but do not over tighten.

## Connection Method 4: TUBE-STRAP

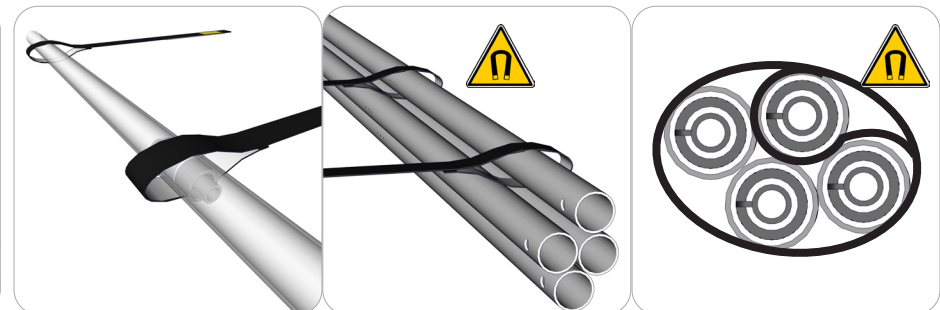

The velcro tube straps add safety when handling the magnetized tubes before, during and after display setup. Follow these steps to bundle the magnetized tubes. First, place 1 tube into 2 strap pockets. Then, place the strap pockets over the labeled magnetized area on the tube. Next, firmly hold the tube and bundle the rest of the magnetized tubes together. The straps hold up to 4 tubes to make 1 bundle. Finally, take the hook velcro and wrap it around the tubes for a secure hold.



Use caution when handling this product around mechanical wrist watches, metal tools, electronic devices, credit cards or any other similar items. DO NOT place any part of the body, such as fingers, hands, etc, between the magnetic surface areas of the components.

# Connection Methods

## Connection Method 5: PLT-BP-LN114-S5

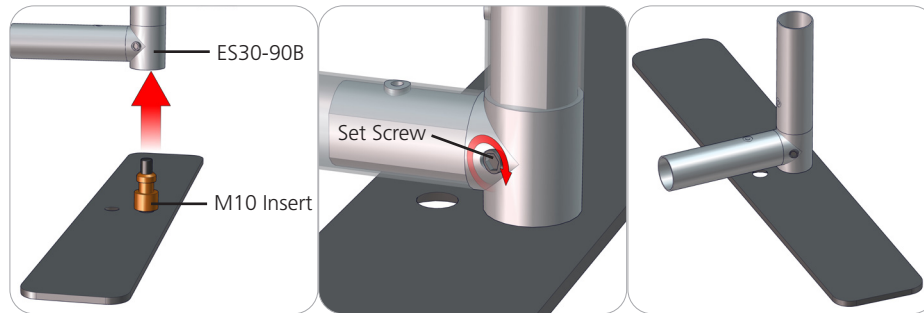

First, loosen the set screw that is on the ES30-90B, then attach the base plate with the M10 insert. Once the base plate is in the desired position, fasten the set screw to hold the insert in place.

## Connection Method 6: PLT-BP-LN114-S5

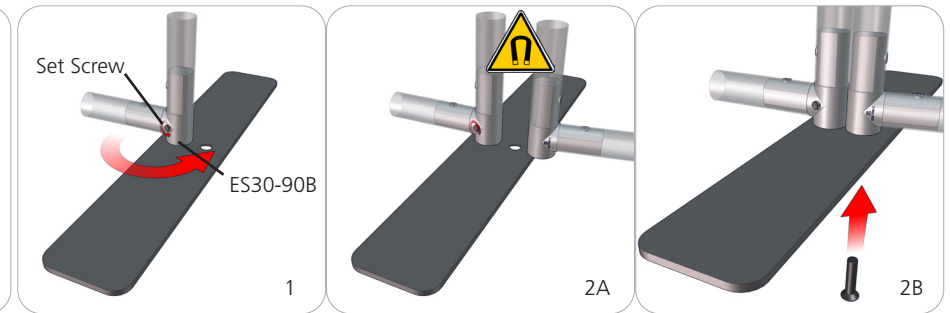

There are two ways you can connect individual frames to make a back wall unit. (1A) The first thing to do is to loosen the set screw that is on the ES30-90B. Do not remove the set screw. Next, rotate the stabilizing base hole to the outside of the frame and tighten the set screw.



(2A) Connecting magnet frames together is easy - the frames will simply magnetize to each other. Use caution when handling the magnetized frames. The frame will rest on the stabilizing base, covering the hole leaving a leveled finished look.

(2B) When your frame does not feature magnets, you will have to use the provided ES30-90B set screw to fasten it onto the base. Don't forget to use your frame clip at the top to level the panels.

# Kit Assembly

## Step by Step

### Step 1.

Gather the components to build the frame. Use the Exploded View and the Labeling Diagram for part labels.

Reference Connection Method(s) 1, 2, 3 and 4 for more details.

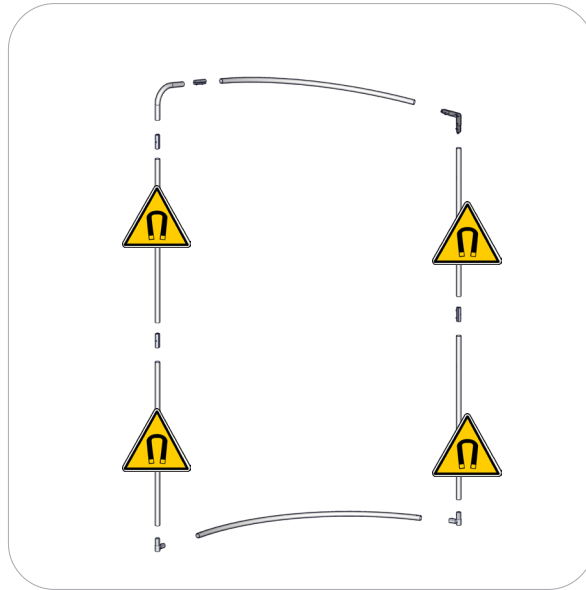

### Step 2.

Locate your pillowcase graphic. With the pillowcase unzipped, encase the frame by covering the frame from top to bottom. Zipper at the bottom.

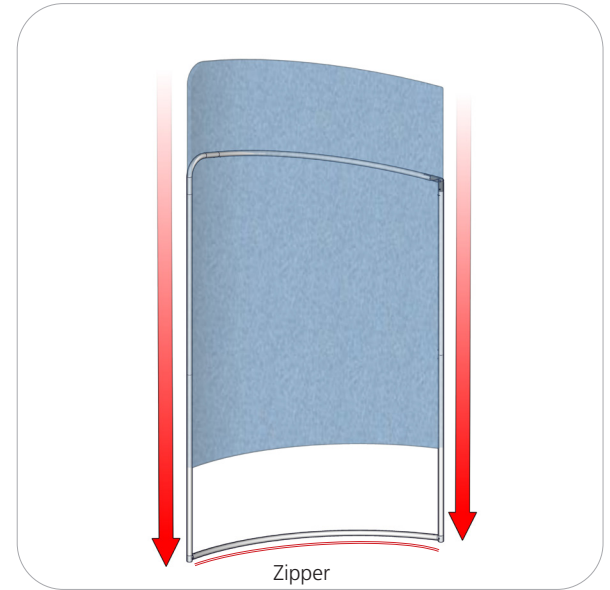
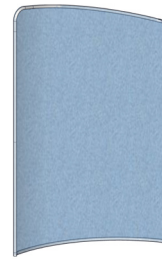

### Step 3.

Locate the stabilizing bases. Attach each foot to the bottom ends of the frame. Use the allen key tool provided to lock the bases in place.

Reference Connection Method(s) 5 for more details.

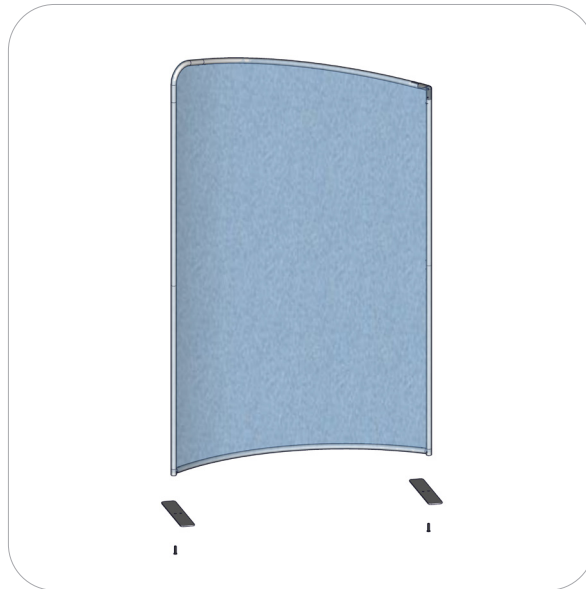

### Step 4.

Setup is complete.

If you are connecting frames side by side, reference Connection Method(s) 6 for more details.



# Modulate Frame 09

## MOD-FRM-09-M

Modulate™ Fabric Banners feature unique angles and shapes, are portable and now are even easier to configure to achieve your dream space! Modulate now offers magnets to attach frames and keep them securely connected together. Choose from multiple frame shapes to design your own combinations – walls, booths, conference rooms, storage areas – the possibilities are endless! The aluminum tube frames feature snap-button and spigot connections that are coupled with a printed pillowcase fabric graphic that slips over the frame and zips closed at the bottom. Universal feet connect the tube frames at the bottom of the display. Each frame comes in a durable, portable carry bag.

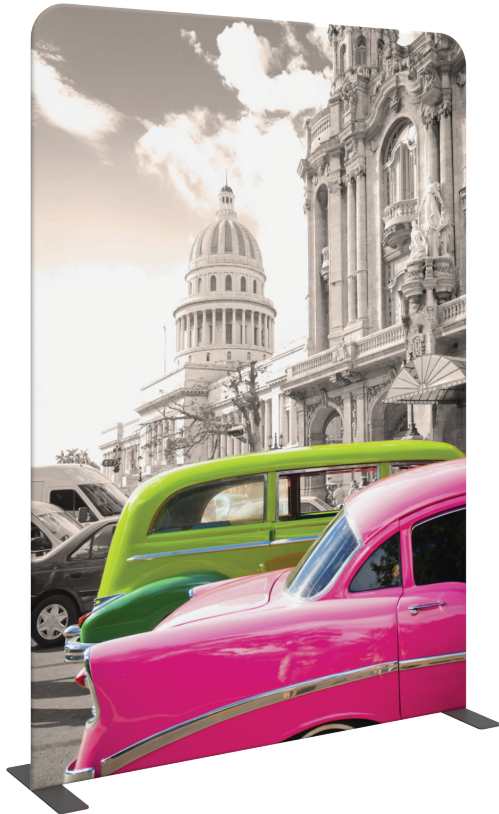

## features and benefits:

- Magnetized premium aluminum tube frame with spigot and snap button assembly
- Easy to store and ship
- Quick to set up
- Weighted feet for added stability
- Comes with carry bag and box
- Zipper pillowcase fabric graphics
- Lifetime limited hardware warranty against manufacturer defects

## dimensions:

|  |  |
|--|--|
| Hardware   | Graphic  |
| Assembled unit:<br>66.74" w x 96" h x 17.72" d<br>1695mm(w) x 2438mm(h) x 450mm(d) | Refer to related graphic template for more information.  |
| Approximate weight:<br>13 lb / 6 kg  | Visit:<br><a href="http://www.exhibitors-handbook.com/graphic-templates">www.exhibitors-handbook.com/graphic-templates</a> |

## Shipping

Packing box(es):  
1 Box

Box size: 60" l x 11" h x 4" d  
1524mm(l) x 279mm(h) x 102mm(d)

Approximate shipping weight:  
15 lb / 7 kg

## additional information:

Graphic material:  
Dye-sublimation zipper pillowcase fabric

When included in a larger kit, a different packaging solution will be listed to accommodate all contents of the kit. Individual packaging no longer provided.

|                              |  |
|------------------------------|--|
|                              | <b>CAUTION</b><br>Interaction with metallic objects may cause Pinch Hazards.     |
|                              | Persons with medical implants be advised magnets may interfere with your device. |
| <b>Strong Magnetic Field</b> |  |

Use caution when handling this product around mechanical wrist watches, metal tools, electronic devices, credit cards or any other similar items. DO NOT place any part of the body, such as fingers, hands, etc, between the magnetic surface areas of the components.

We are continually improving and modifying our product range and reserve the right to vary the specifications without prior notice. All dimensions and weights quoted are approximate and we accept no responsibility for variance. E&OE. See Graphic Templates for graphic bleed specifications.

# Included In Your Kit

Tools, Components, Connectors, Tubes & Graphics



HEX KEY SET x1

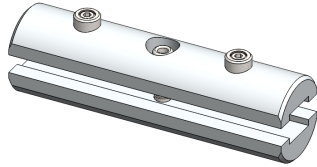

ES30 x7

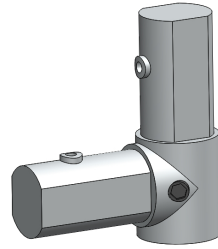

ES30-90B x2



PLT-BP-LN114-S5-450 x2

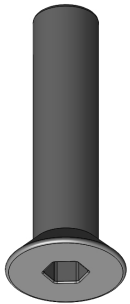

LN114-SCRW x2



MOD-FRM-09-T5 x2



MOD-FRM-09-T8 x1



MOD-FRM-09-T7-M-T x2



MOD-FRM-09-T6-M-B x2



MOD-FRM-09-T6-M-T x2

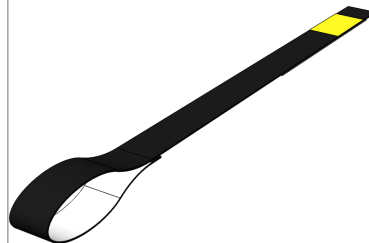

TUBE-STRAP-30-M x2



MOD-FRM-09-G x1

# Exploded View

MOD-FRM-09-M

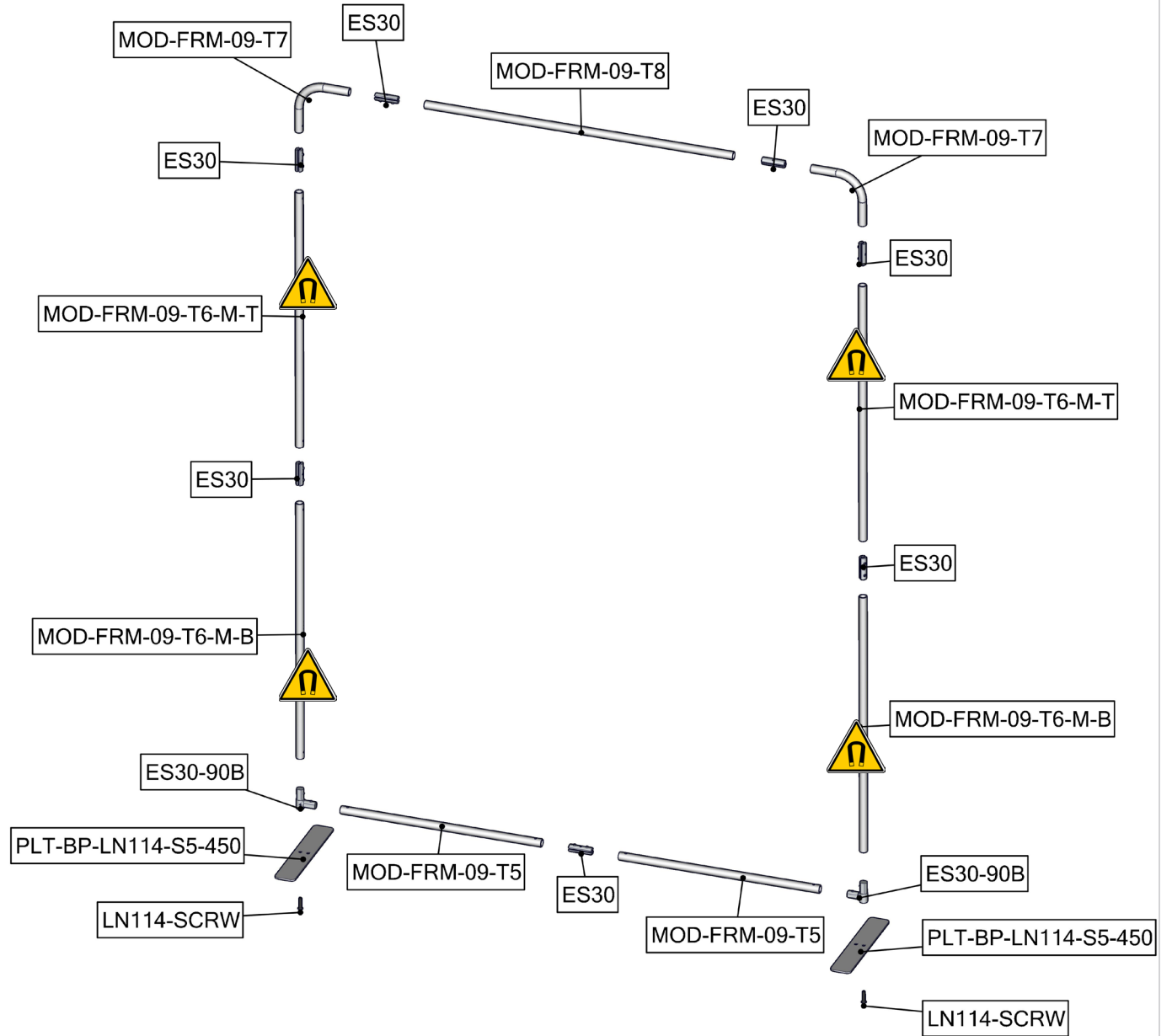

|                              |  |
|------------------------------|--|
|                              | <b>CAUTION</b><br>Interaction with metallic objects may cause Pinch Hazards.<br>Persons with medical implants be advised magnets may interfere with your device. |
| <b>Strong Magnetic Field</b> |  |

Use caution when handling this product around mechanical wrist watches, metal tools, electronic devices, credit cards or any other similar items. DO NOT place any part of the body, such as fingers, hands, etc, between the magnetic surface areas of the components.



# Labeling Diagram

MOD-FRM-09-M

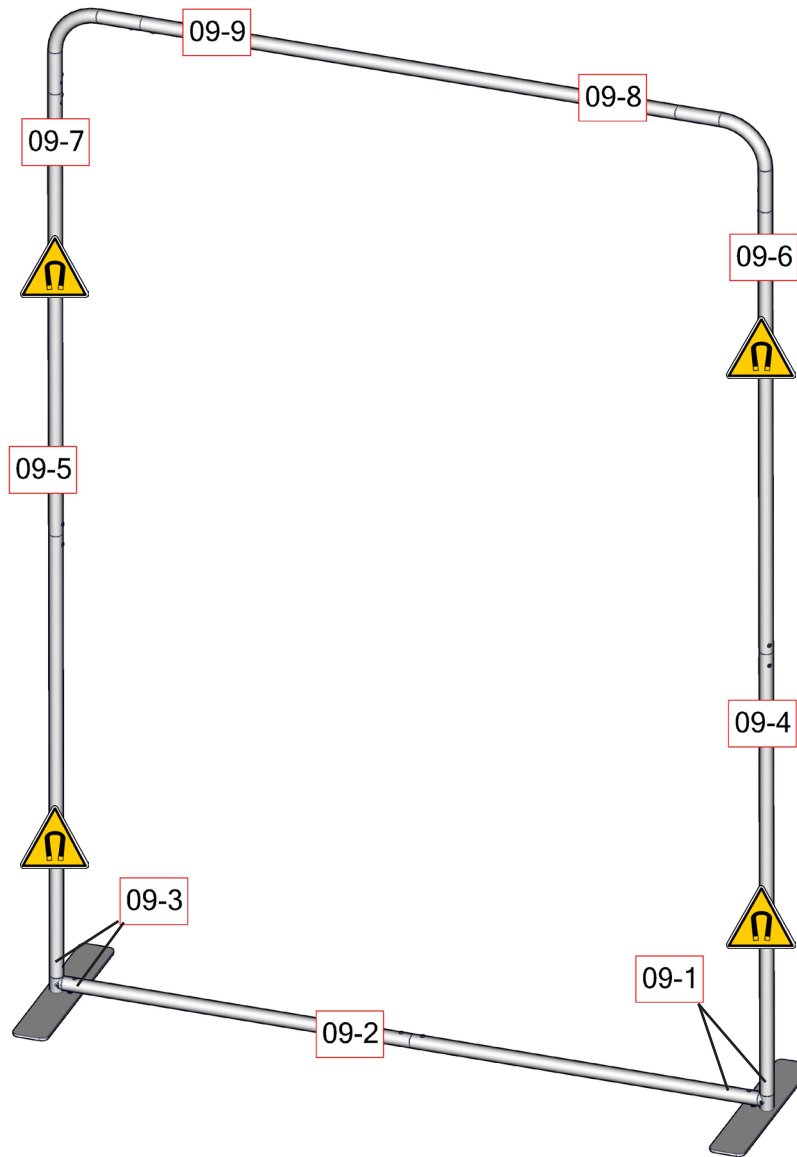

|                              |  |
|------------------------------|--|
|                              | <b>CAUTION</b>   |
|                              | Interaction with metallic objects may cause Pinch Hazards.<br>Persons with medical implants be advised magnets may interfere with your device. |
| <b>Strong Magnetic Field</b> |  |

Use caution when handling this product around mechanical wrist watches, metal tools, electronic devices, credit cards or any other similar items. DO NOT place any part of the body, such as fingers, hands, etc, between the magnetic surface areas of the components.

# Connection Methods

## Connection Method 1: ES30

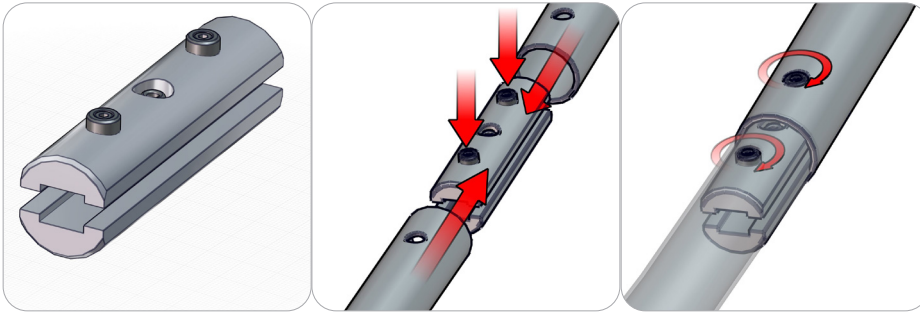

For spigot connections, compress the unlocked connector and slide into the tube lock access hole. Lock both screws carefully using your allen key tool. Be sure to lock securely, but do not over tighten. Do not force the connection and be careful with the tube edges, they may be sharp. To disassemble, unlocked connector press the snap button and pull apart.

## Connection Method 2: ES30-90B

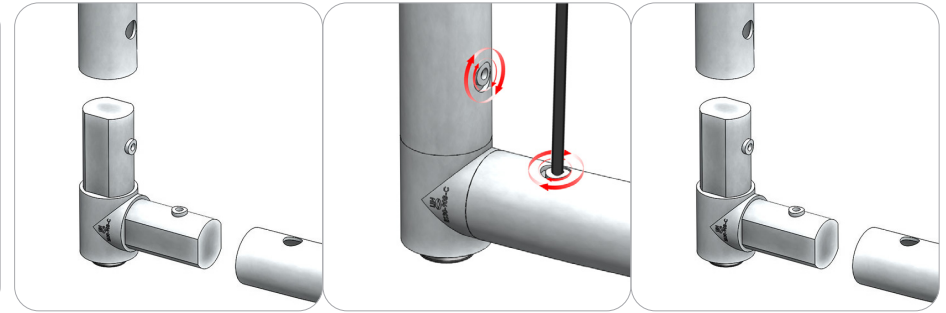

Compress one unlocked end of the connector and slide it through one tube end. Compress the other end of the connector and slide the second tube on. Lock both screws carefully using your allen key tool. Be sure to lock securely, but do not over tighten.

## Connection Method 3: TUBE-STRAP

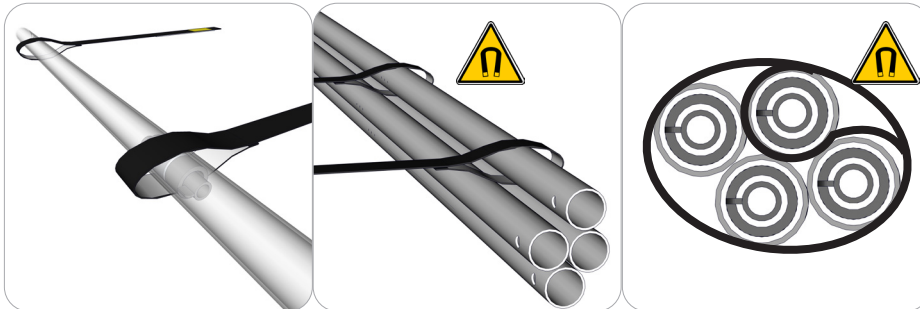

The velcro tube straps add safety when handling the magnetized tubes before, during and after display setup. Follow these steps to bundle the magnetized tubes. First, place 1 tube into 2 strap pockets. Then, place the strap pockets over the labeled magnetized area on the tube. Next, firmly hold the tube and bundle the rest of the magnetized tubes together. The straps hold up to 4 tubes to make 1 bundle. Finally, take the hook velcro and wrap it around the tubes for a secure hold.



Use caution when handling this product around mechanical wrist watches, metal tools, electronic devices, credit cards or any other similar items. DO NOT place any part of the body, such as fingers, hands, etc, between the magnetic surface areas of the components.

# Connection Methods

## Connection Method 4: PLT-BP-LN114-S5

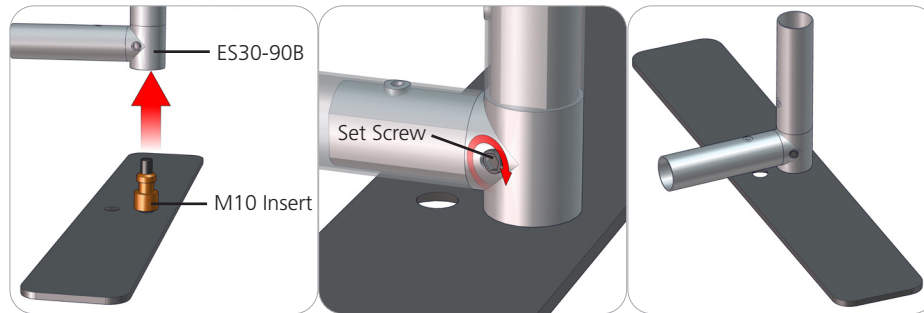

First, loosen the set screw that is on the ES30-90B, then attach the base plate with the M10 insert. Once the base plate is in the desired position, fasten the set screw to hold the insert in place.

## Connection Method 5: PLT-BP-LN114-S5

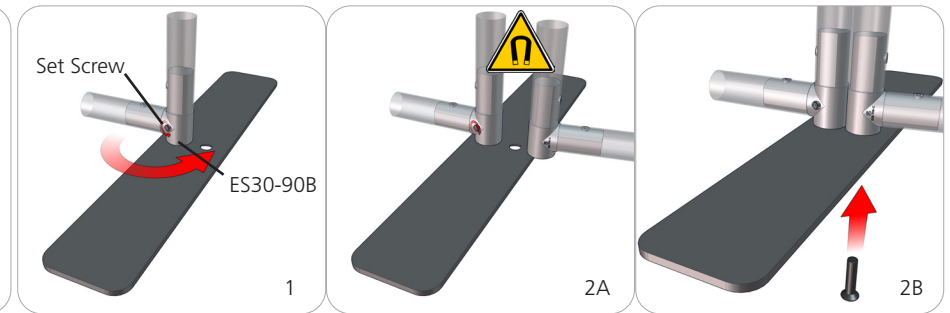

There are two ways you can connect individual frames to make a back wall unit. (1A) The first thing to do is to loosen the set screw that is on the ES30-90B. Do not remove the set screw. Next, rotate the stabilizing base hole to the outside of the frame and tighten the set screw.



(2A) Connecting magnet frames together is easy - the frames will simply magnetize to each other. Use caution when handling the magnetized frames. The frame will rest on the stabilizing base, covering the hole leaving a leveled finished look.

(2B) When your frame does not feature magnets, you will have to use the provided ES30-90B set screw to fasten it onto the base. Don't forget to use your frame clip at the top to level the panels.

# Kit Assembly

## Step by Step

### Step 1.

Gather the components to build the frame. Use the Exploded View and the Labeling Diagram for part labels.

Reference Connection Method(s) 1, 2 and 3 for more details.

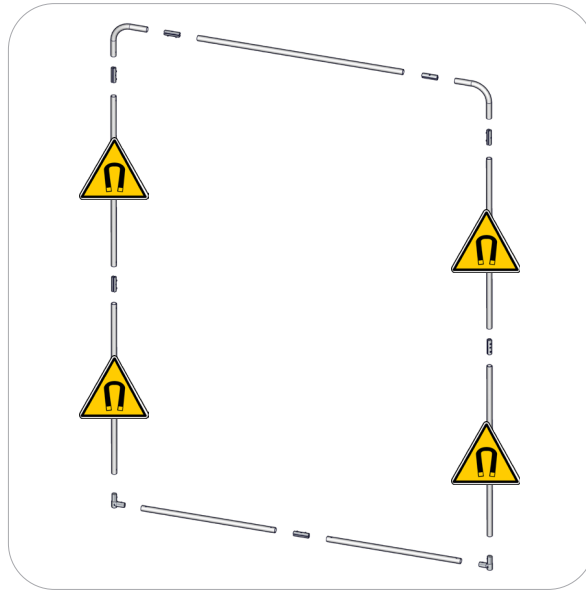
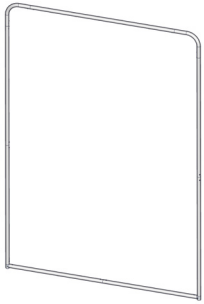

### Step 2.

Locate your pillowcase graphic. With the pillowcase unzipped, encase the frame by covering the frame from top to bottom. Zipper at the bottom.

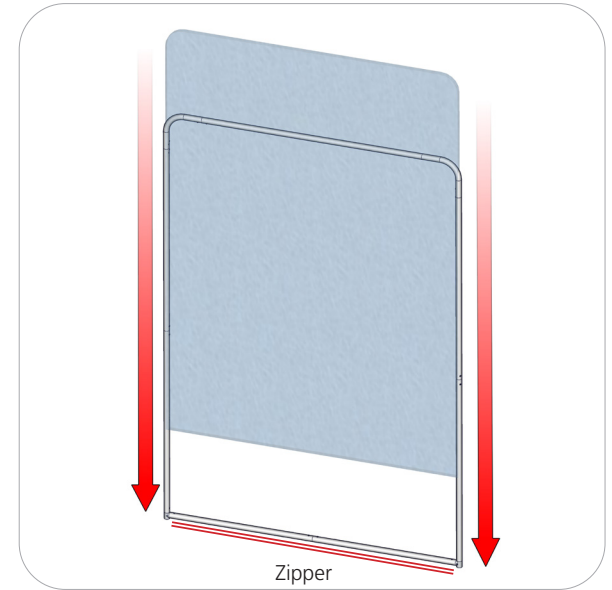
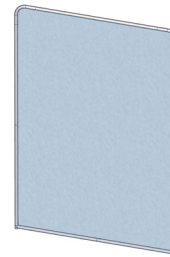

### Step 3.

Locate the stabilizing bases. Attach each foot to the bottom ends of the frame. Use the allen key tool provided to lock the bases in place.

Reference Connection Method(s) 4 for more details.

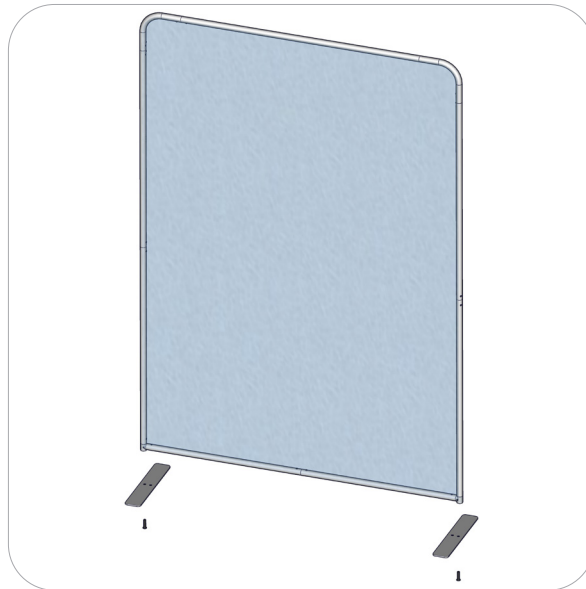

### Step 4.

Setup is complete.

If you are connecting frames side by side, reference Connection Method(s) 5 for more details.



# Modulate Frame 10

## MOD-FRM-10-M

Modulate™ Fabric Banners feature unique angles and shapes, are portable and now are even easier to configure to achieve your dream space! Modulate now offers magnets to attach frames and keep them securely connected together. Choose from multiple frame shapes to design your own combinations – walls, booths, conference rooms, storage areas – the possibilities are endless! The aluminum tube frames feature snap-button and spigot connections that are coupled with a printed pillowcase fabric graphic that slips over the frame and zips closed at the bottom. Universal feet connect the tube frames at the bottom of the display. Each frame comes in a durable, portable carry bag.



## features and benefits:

- Magnetized premium aluminum tube frame with spigot and snap button assembly
- Easy to store and ship
- Quick to set up
- Weighted feet for added stability
- Comes with carry bag and box
- Zipper pillowcase fabric graphics
- Lifetime limited hardware warranty against manufacturer defects

## dimensions:

|   |  |
|---|--|
| Hardware  | Graphic  |
| Assembled unit:<br>32.74" w x 96" h x 17.72" d<br>832mm(w) x 2438mm(h) x 450mm(d) | Refer to related graphic template for more information.  |
| Approximate weight:<br>11 lb / 5 kg   | Visit:<br><a href="http://www.exhibitors-handbook.com/graphic-templates">www.exhibitors-handbook.com/graphic-templates</a> |

## Shipping

Packing box(es):  
1 Box

Box size: 48" l x 11" h x 4" d  
1219mm(l) x 279mm(h) x 102mm(d)

Approximate shipping weight:  
13 lb / 6 kg

## additional information:

Graphic material:  
Dye-sublimation zipper pillowcase fabric

When included in a larger kit, a different packaging solution will be listed to accommodate all contents of the kit. Individual packaging no longer provided.

|                              |  |
|------------------------------|--|
|                              | <b>CAUTION</b><br>Interaction with metallic objects may cause Pinch Hazards.     |
|                              | Persons with medical implants be advised magnets may interfere with your device. |
| <b>Strong Magnetic Field</b> |  |

Use caution when handling this product around mechanical wrist watches, metal tools, electronic devices, credit cards or any other similar items. DO NOT place any part of the body, such as fingers, hands, etc, between the magnetic surface areas of the components.

We are continually improving and modifying our product range and reserve the right to vary the specifications without prior notice. All dimensions and weights quoted are approximate and we accept no responsibility for variance. E&OE. See Graphic Templates for graphic bleed specifications.

# Included In Your Kit

Tools, Components, Connectors, Tubes & Graphics



HEX KEY SET x1

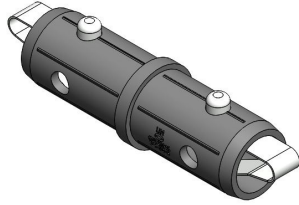

TC-30-S x4

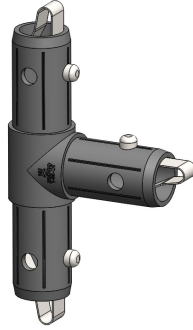

TC-30-T x2

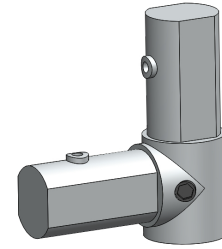

ES30-90B x2



PLT-BP-LN114-S5-450 x2

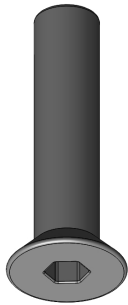

LN114-SCRW x2



MOD-FRM-10-T3 x2



MOD-FRM-10-T4 x1



MOD-FRM-10-T1 x2



MOD-FRM-10-T2-M-B x2



MOD-FRM-10-T2-M-T x2

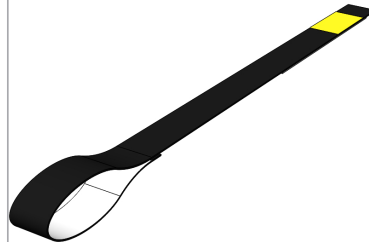

TUBE-STRAP-30-M x2

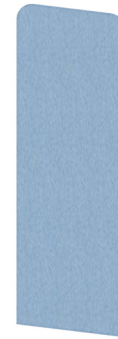

MOD-FRM-10-G x1

# Exploded View

MOD-FRM-10-M

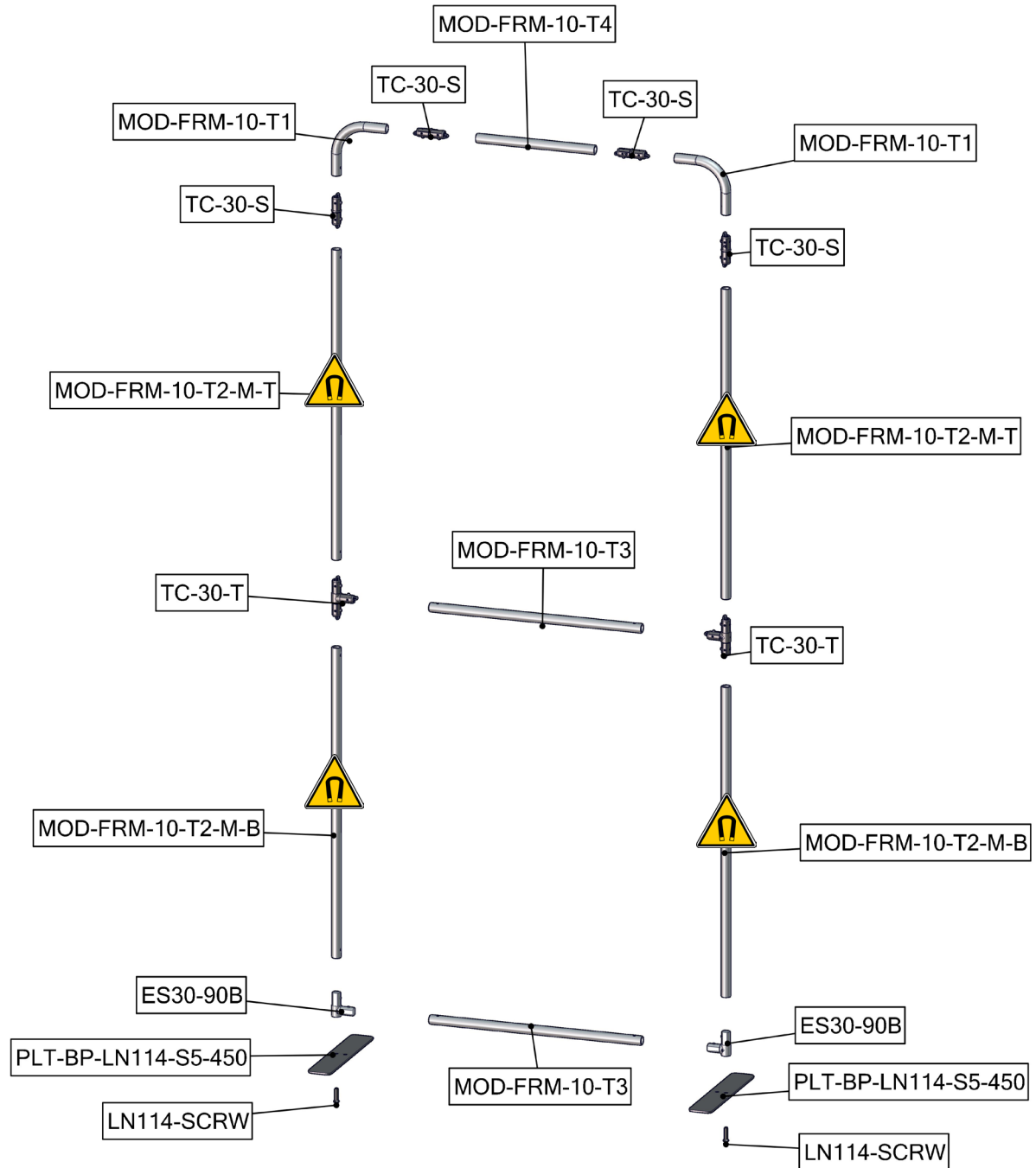

|                              |   |
|------------------------------|---|
|                              | <b>CAUTION</b>  |
|                              | <p>Interaction with metallic objects may cause Pinch Hazards.</p> <p>Persons with medical implants be advised magnets may interfere with your device.</p> |
| <b>Strong Magnetic Field</b> |   |

Use caution when handling this product around mechanical wrist watches, metal tools, electronic devices, credit cards or any other similar items. DO NOT place any part of the body, such as fingers, hands, etc, between the magnetic surface areas of the components.

# Labeling Diagram

MOD-FRM-10-M

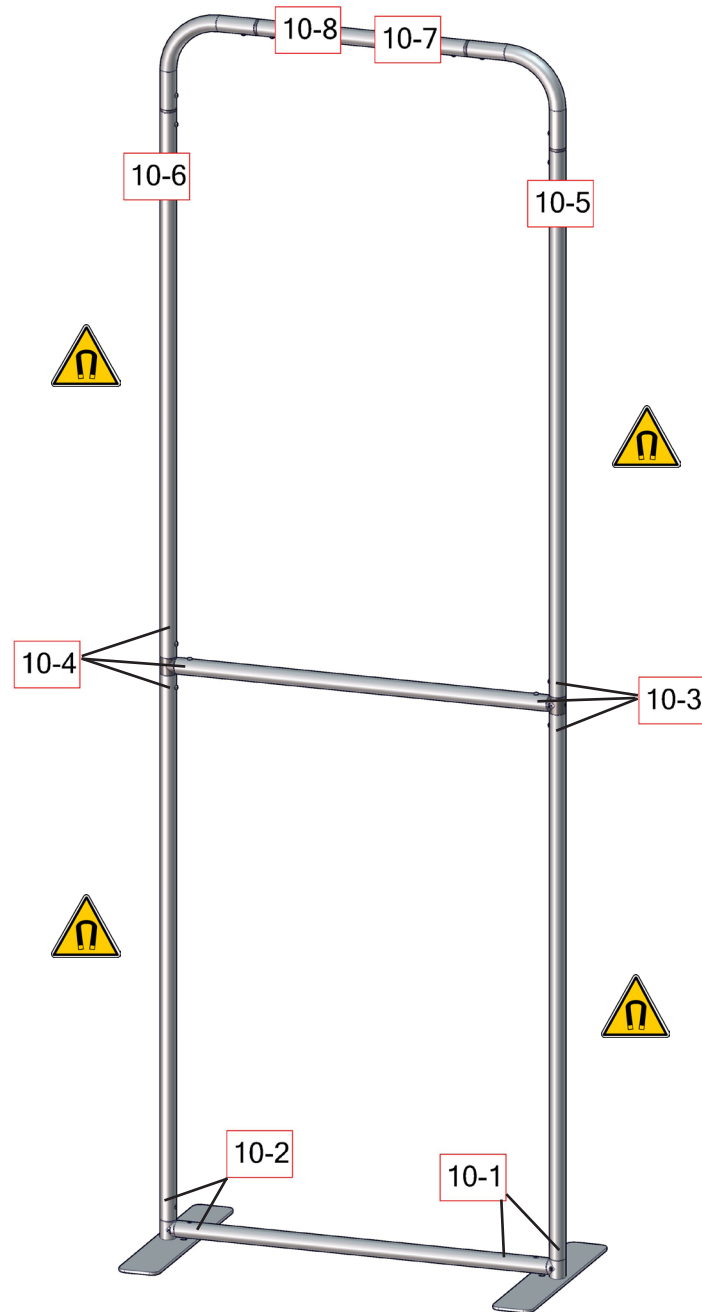

|                              |  |
|------------------------------|--|
|                              | <b>CAUTION</b>   |
|                              | Interaction with metallic objects may cause Pinch Hazards.<br>Persons with medical implants be advised magnets may interfere with your device. |
| <b>Strong Magnetic Field</b> |  |

Use caution when handling this product around mechanical wrist watches, metal tools, electronic devices, credit cards or any other similar items. DO NOT place any part of the body, such as fingers, hands, etc, between the magnetic surface areas of the components.



# Connection Methods

## Connection Method 1: TC-30-T

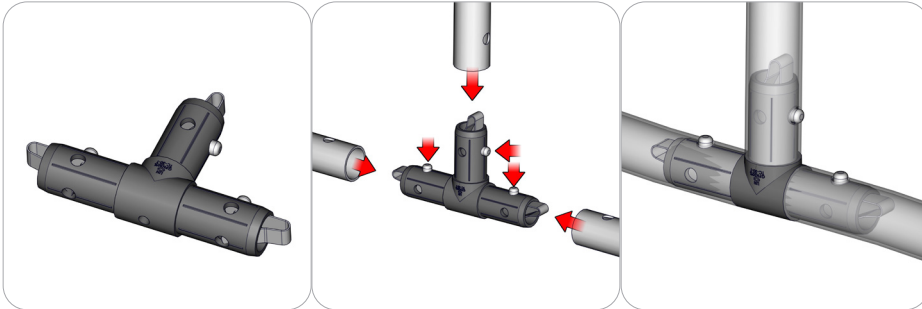

Take the plastic connector and make sure the snap buttons are in proper position for the frame tube holes. Simply press the snap button with your thumb and carefully slide the tube onto the connector. The snap button should pop through. Some twisting may be necessary to assure the snap button has popped all the way through the tube hole. Do not force the connection and be careful with the tube edges, they may be sharp.

## Connection Method 2: TC-30-S

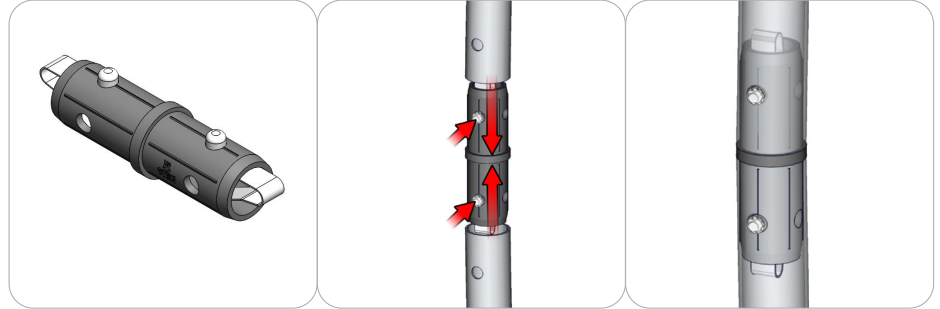

Take the plastic connector and make sure the snap buttons are in proper position for the frame tube holes. Simply press the snap button with your thumb and carefully slide the tube onto the connector. The snap button should pop through. Some twisting may be necessary to assure the snap button has popped all the way through the tube hole. Do not force the connection and be careful with the tube edges, they may be sharp.

## Connection Method 3: ES30-90B

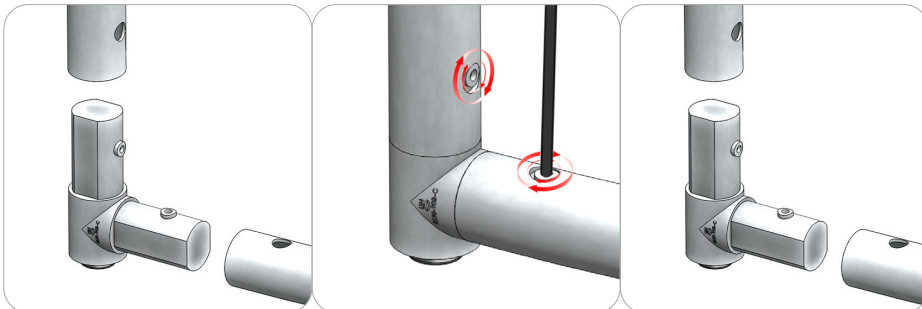

Compress one unlocked end of the connector and slide it through one tube end. Compress the other end of the connector and slide the second tube on. Lock both screws carefully using your allen key tool. Be sure to lock securely, but do not over tighten.

## Connection Method 4: TUBE-STRAP

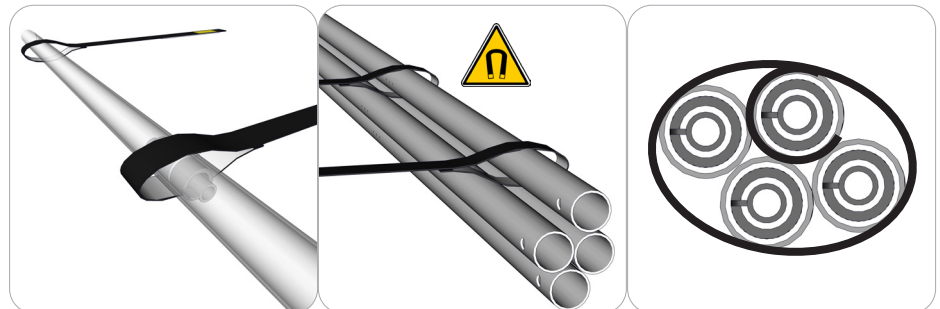

The velcro tube straps add safety when handling the magnetized tubes before, during and after display setup. Follow these steps to bundle the magnetized tubes. First, place 1 tube into 2 strap pockets. Then, place the strap pockets over the labeled magnetized area on the tube. Next, firmly hold the tube and bundle the rest of the magnetized tubes together. The straps hold up to 4 tubes to make 1 bundle. Finally, take the hook velcro and wrap it around the tubes for a secure hold.



Use caution when handling this product around mechanical wrist watches, metal tools, electronic devices, credit cards or any other similar items. DO NOT place any part of the body, such as fingers, hands, etc, between the magnetic surface areas of the components.

# Connection Methods

## Connection Method 5: PLT-BP-LN114-S5

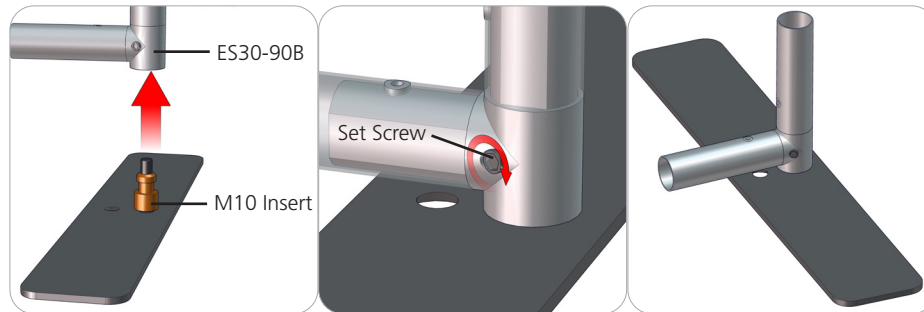

First, loosen the set screw that is on the ES30-90B, then attach the base plate with the M10 insert. Once the base plate is in the desired position, fasten the set screw to hold the insert in place.

## Connection Method 6: PLT-BP-LN114-S5

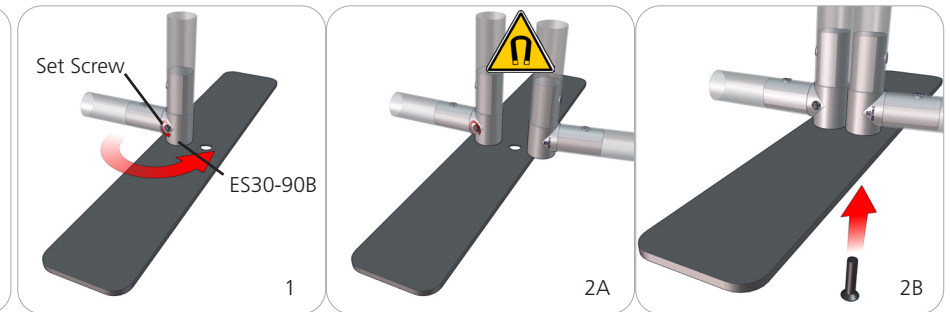

There are two ways you can connect individual frames to make a back wall unit. (1A) The first thing to do is to loosen the set screw that is on the ES30-90B. Do not remove the set screw. Next, rotate the stabilizing base hole to the outside of the frame and tighten the set screw.



(2A) Connecting magnet frames together is easy - the frames will simply magnetize to each other. Use caution when handling the magnetized frames. The frame will rest on the stabilizing base, covering the hole leaving a leveled finished look.

(2B) When your frame does not feature magnets, you will have to use the provided ES30-90B set screw to fasten it onto the base. Don't forget to use your frame clip at the top to level the panels.

# Kit Assembly

## Step by Step

### Step 1.

Gather the components to build the frame. Use the Exploded View and the Labeling Diagram for part labels.

Reference Connection Method(s) 1, 2, 3 and 4 for more details.

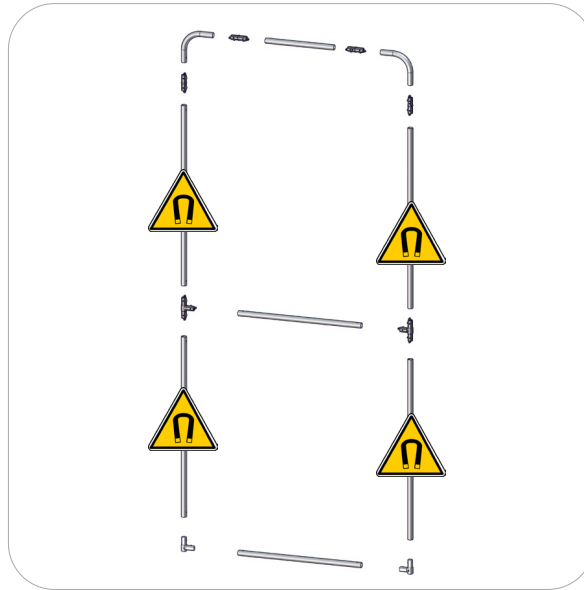

### Step 2.

Locate your pillowcase graphic. With the pillowcase unzipped, encase the frame by covering the frame from top to bottom. Zipper at the bottom.

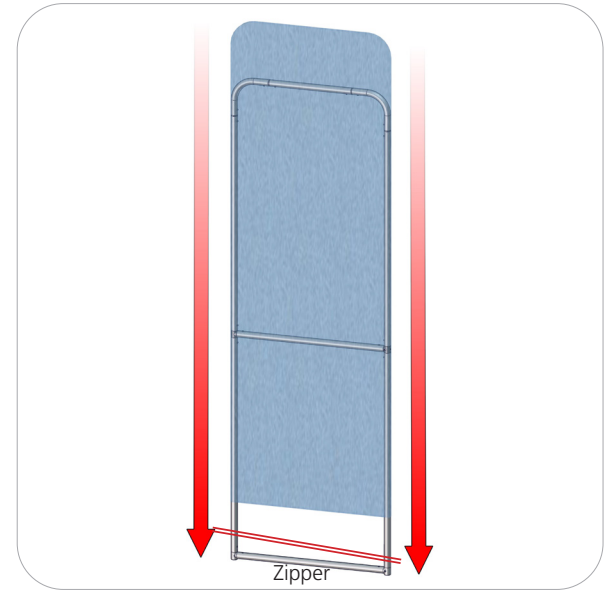

### Step 3.

Locate the stabilizing bases. Attach each foot to the bottom ends of the frame. Use the allen key tool provided to lock the bases in place.

Reference Connection Method(s) 5 for more details.

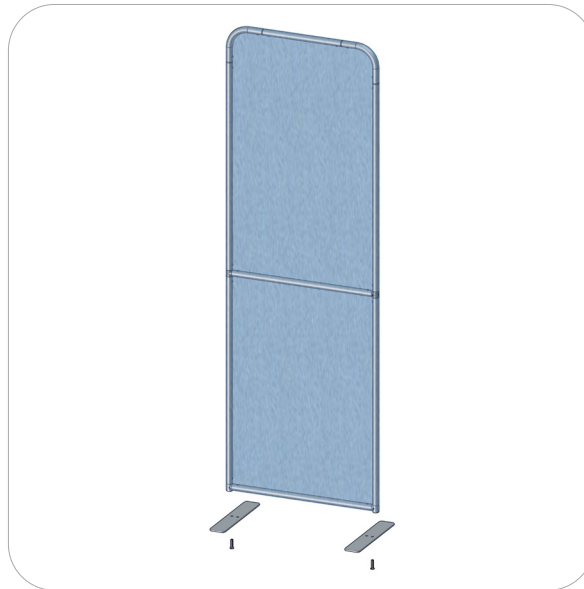

### Step 4.

Setup is complete.

If you are connecting frames side by side, reference Connection Method(s) 6 for more details.

