

Zoom Flex EDGE Fiber Flags

ZOOM-FLX-SM-E,
ZOOM-FLX-M-E,
ZOOM-FLX-LG-E,
ZOOM-FLX-XL-E

Zoom Flex Edge Flags are a full fiber pole flag that is perfect for any indoor or outdoor event. This unique banner design allows the graphic to rotate in the wind. Hardware includes the outdoor ground stake.



features and benefits:

- Can be used indoors or out
- Graphic rotates in wind
- Water fillable donut adds stability to the floor base (recommended)
- Double-sided graphic available
- Four sizes available: Small, Medium, Large, and Extra Large
- One year hardware warranty against manufacturer defects

dimensions:

Hardware	Graphic
<p>Assembled unit: Hardware only (when graphic is applied the dimensions vary slightly). Small: 84.13”h x 1.25”w x 1.75”d 2137mm(h) x 32mm(w) x 45mm(d)</p> <p>Medium: 116.13”h x 1.25”w x 1.75”d 2950mm(h) x 32mm(w) x 45mm(d)</p> <p>Large: 160.13”h x 1.25”w x 1.75”d 4067mm(h) x 32mm(w) x 45mm(d)</p> <p>X-Large: 202.1”h x 1.25”w x 1.75”d 5133mm(h) x 32mm(w) x 45mm(d)</p>	<p>For more information visit: www.exhibitors-handbook.com/graphic-templates</p> <p>Additional information:</p> <p>Double-sided graphic includes opaque liner</p> <p>For applications below 40 degrees fahrenheit, use sand in place of water.</p> <p>Graphics will pack in a separate box</p>
Shipping	Additional base options
<p>Shipping dimensions (hardware only): Small: 44”(l) x 6”(w) x 4”(d) 1118mm(l) x 152mm(w) x 102mm(d)</p> <p>Medium: 61”(l) x 6”(w) x 4”(d) 1550mm(l) x 152mm(w) x 102mm(d)</p> <p>Large: 56”(l) x 6”(w) x 4”(d) 1422mm(l) x 152mm(w) x 102mm(d)</p> <p>X-Large: 57”(l) x 6”(w) x 4”(d) 1449mm(l) x 152mm(w) x 102mm(d)</p> <p>Approximate weight: Small: 6lbs Medium: 7lbs Large: 8lbs X-Large: 9lbs</p>	<p>*See supplement for more information on bases</p>

We are continually improving and modifying our product range and reserve the right to vary the specifications without prior notice. All dimensions and weights quoted are approximate and we accept no responsibility for variance. E&OE. See Graphic Templates for graphic bleed specifications.

SET-UP

Flag Size:	Number of Poles
Small	3
Medium	4
Large	4
Extra Large	5

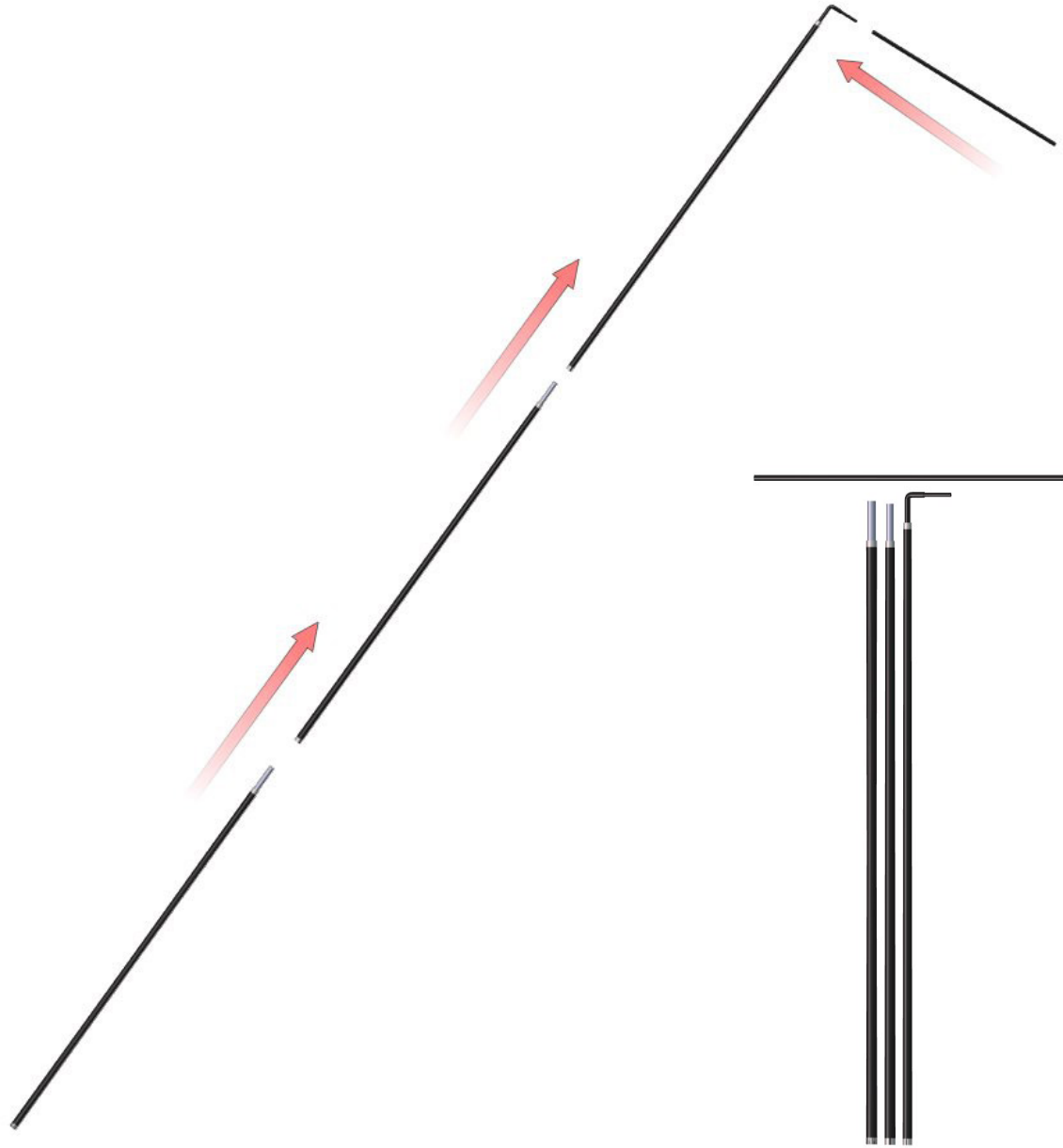

Attaching Graphic

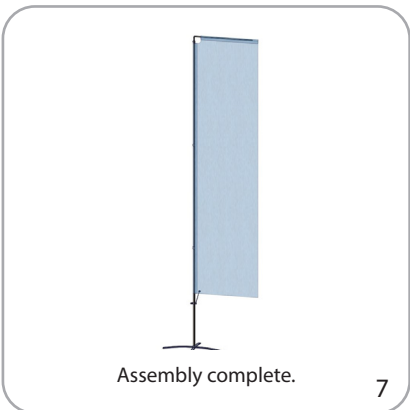
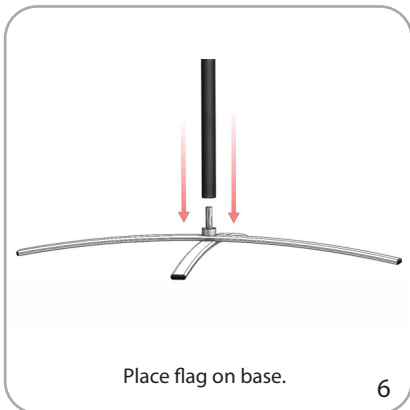
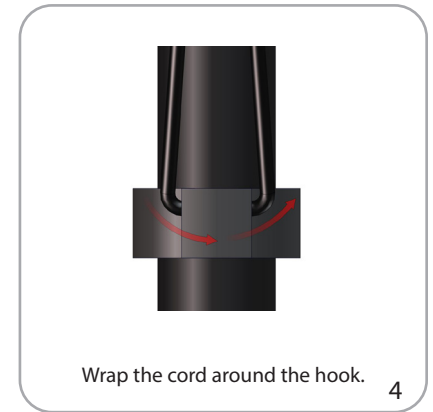
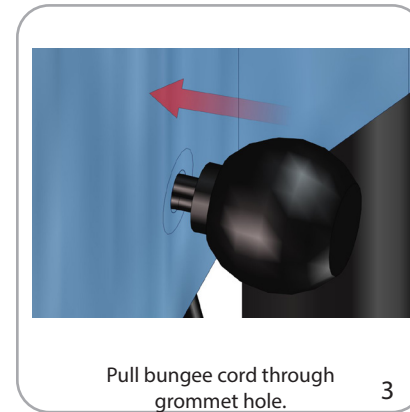
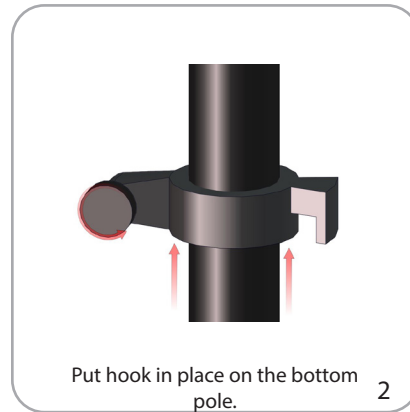
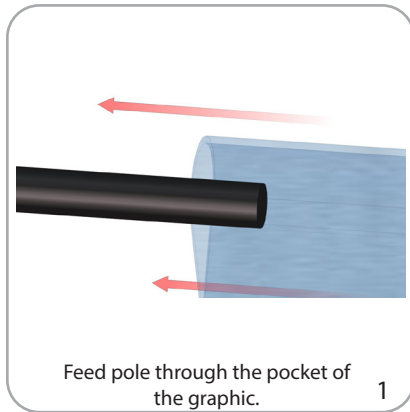

Zoom Flag Bases

Zoom Cross Base



ZOOM-FLX-CB

*Water ring recommended

Assembled dimensions and weight:
31"W x 24"D x 6.75"H 4lbs
Shipping dimensions and weight:
4" x 2" 5lbs

Zoom Square Steel Base

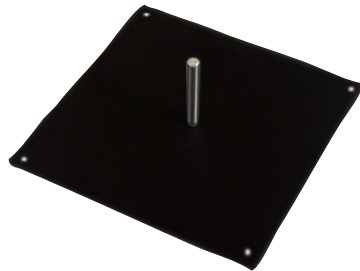

ZOOM-FLX-SQ

*Water ring recommended

Assembled dimensions and weight:
17.5"W x 17.5"D x 5"H 28lbs
Shipping dimensions and weight:
19"L x 18.5"W x 3.5"D 30lbs

Zoom Water Ring Base Support



ZOOM-FLX-WR

*Holds up to one gallon of liquid

Assembled dimensions and weight:
20.28"W x 20.28"D x 5"H 11lbs
Shipping dimensions and weight:
8"L x 4"W x 4"D 2lbs

Zoom Fillable Base



ZOOM-FLX-FB

*Holds up to 7 gallons of liquid

Assembled dimensions and weight:
19.7"W x 19.7"D x 10.25"H 7lbs
Shipping dimensions and weight:
21"L x 22"W x 10"D 9lbs

Zoom Ground Stake Base



ZOOM-FLX-STK

Ground Stake

Assembled dimensions and weight:
23.75"W x 1.25"D x 1.75"H 3lbs
Shipping dimensions and weight:
25"L x 2"W x 2"D 4lbs

Zoom Auger Base



ZOOM-FLX-AGR

Screw in plastic base

Assembled dimensions and weight:
8.88"W x 3.75"D x 21.75"H 3lbs
Shipping dimensions and weight:
24"L x 6"W x 6"D 4lbs

Zoom Drive-Over Base

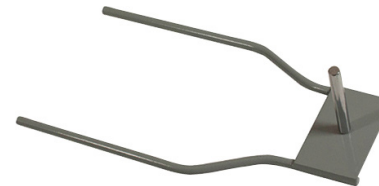

ZOOM-FLX-DO

Capable of being driven on or over

Assembled dimensions and weight:
23.62"W x 7.87"D x 5.71"H 14lbs
Shipping dimensions and weight:
24"L x 10"W x 3"D 16lbs