

# FORMULATE ARCH - 05

## ARCH-05

Formulate® Arches add architecture and design to any event or interior space! Easily create and define a stunning entryway, focal point or stage set at your next trade-show or event with Formulate Arches.

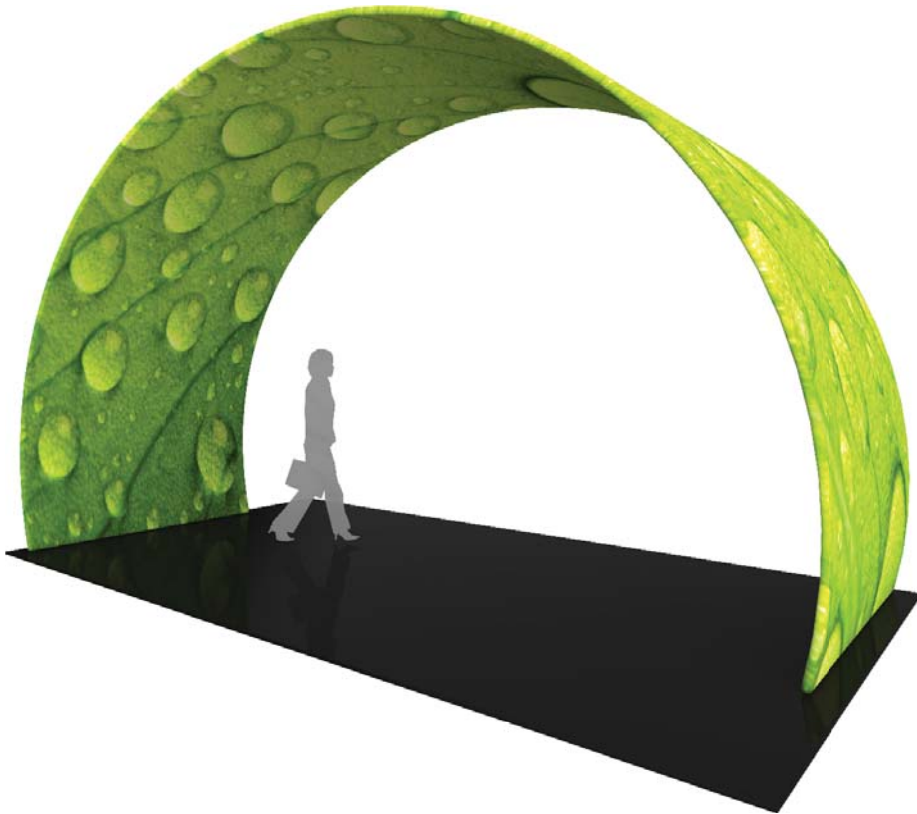

## features and benefits:

- State-of-the-art 50mm curved aluminum tube frame with sturdy internal spigots
- Fits perfectly in a 30ft island space
- Kit includes: one frame, one dye-sublimated zipper pillowcase graphic, and two wheeled molded OCE storage and transit cases
- Lifetime hardware warranty against manufacturer defects

## dimensions:

### Hardware

Assembled unit:  
234.25" w x 144" h x 121" d  
5949mm(w) x 3657mm(h) x 3073mm(d)

Approximate weight with cases:  
147 lbs / 67 kgs

### Shipping

Packing case(s):  
2 OCE Case

Shipping dimensions:  
OCE: Expandable case length (l) may vary  
40" - 66" l x 18" w x 18" h  
1016mm-1677mm(l) x 458mm(w) x 458mm(h)

Approximate total shipping weight  
(includes cases & graphics):  
182 lbs / 83kgs

### Graphic

Refer to related graphic template for more information.

Visit:  
[www.exhibitors-handbook.com/graphic-templates](http://www.exhibitors-handbook.com/graphic-templates)

## additional information:

Graphic material:  
dye-sublimation zipper pillowcase fabric

We are continually improving and modifying our product range and reserve the right to vary the specifications without prior notice. All dimensions and weights quoted are approximate and we accept no responsibility for variance. E&OE. See Graphic Templates for graphic bleed specifications.

# Included In Your Kit

Tools, Components,  
& Connectors



ALLEN KEY SET x1



ES30 x10



ES50 x22

Graphics



ARCH-05-G x1

# Included In Your Kit

Tubes

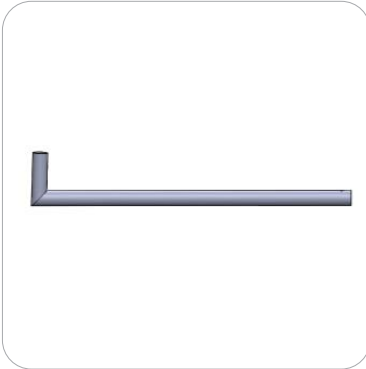

FMLT-ARCH-05-T1 x2



FMLT-ARCH-05-T2 x8

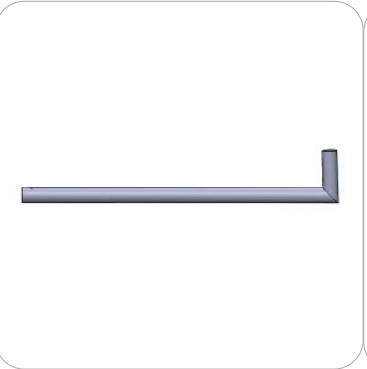

FMLT-ARCH-05-T3 x2



FMLT-ARCH-05-T4 x2



FMLT-ARCH-05-T5 x2



FMLT-ARCH-05-T6 x1



FMLT-ARCH-05-T7 x1



FMLT-ARCH-05-T8 x4



FMLT-ARCH-05-T9 x2

# Exploded View

ARCH-05

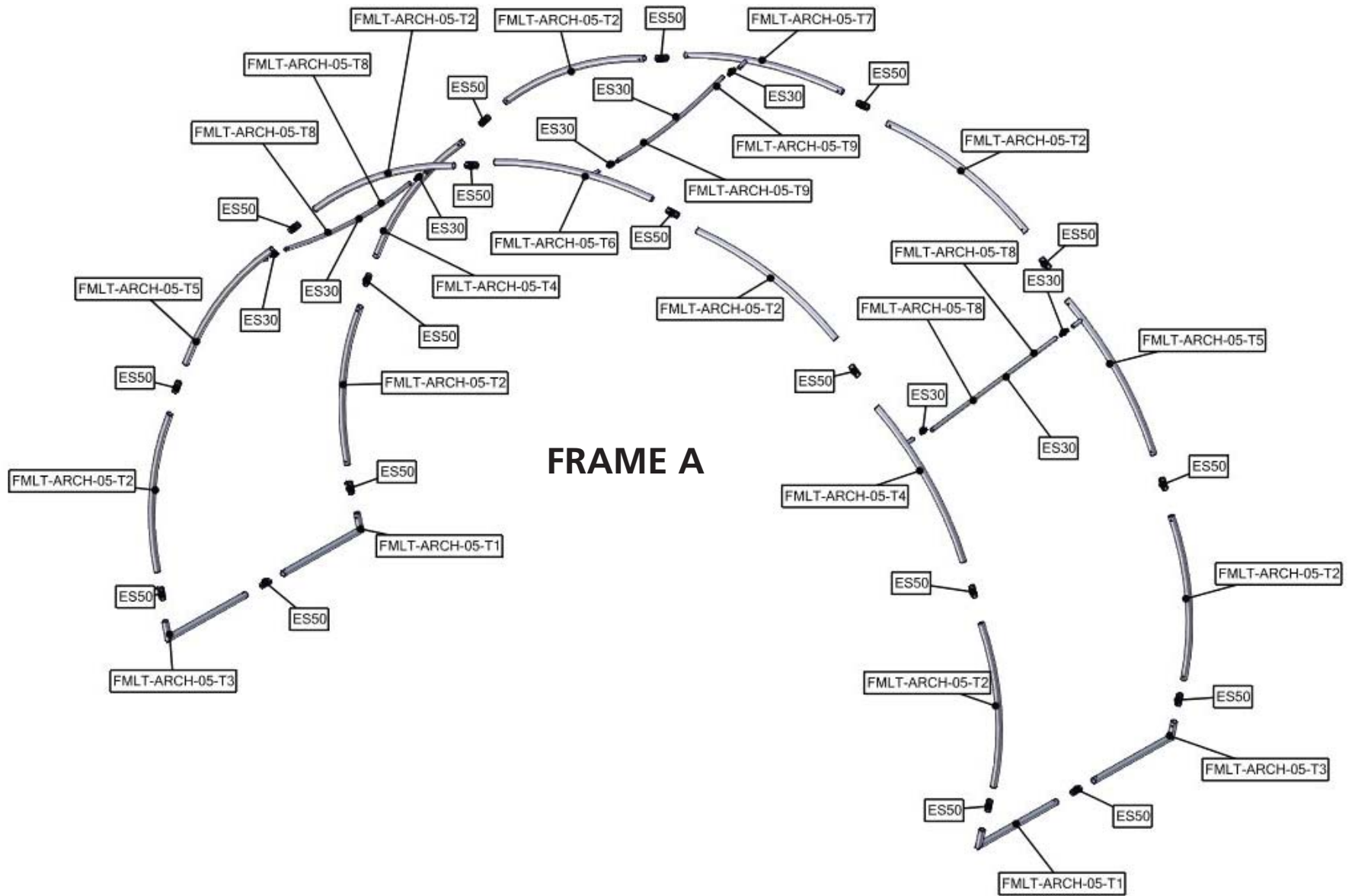

# Labeling Diagram

ARCH-05

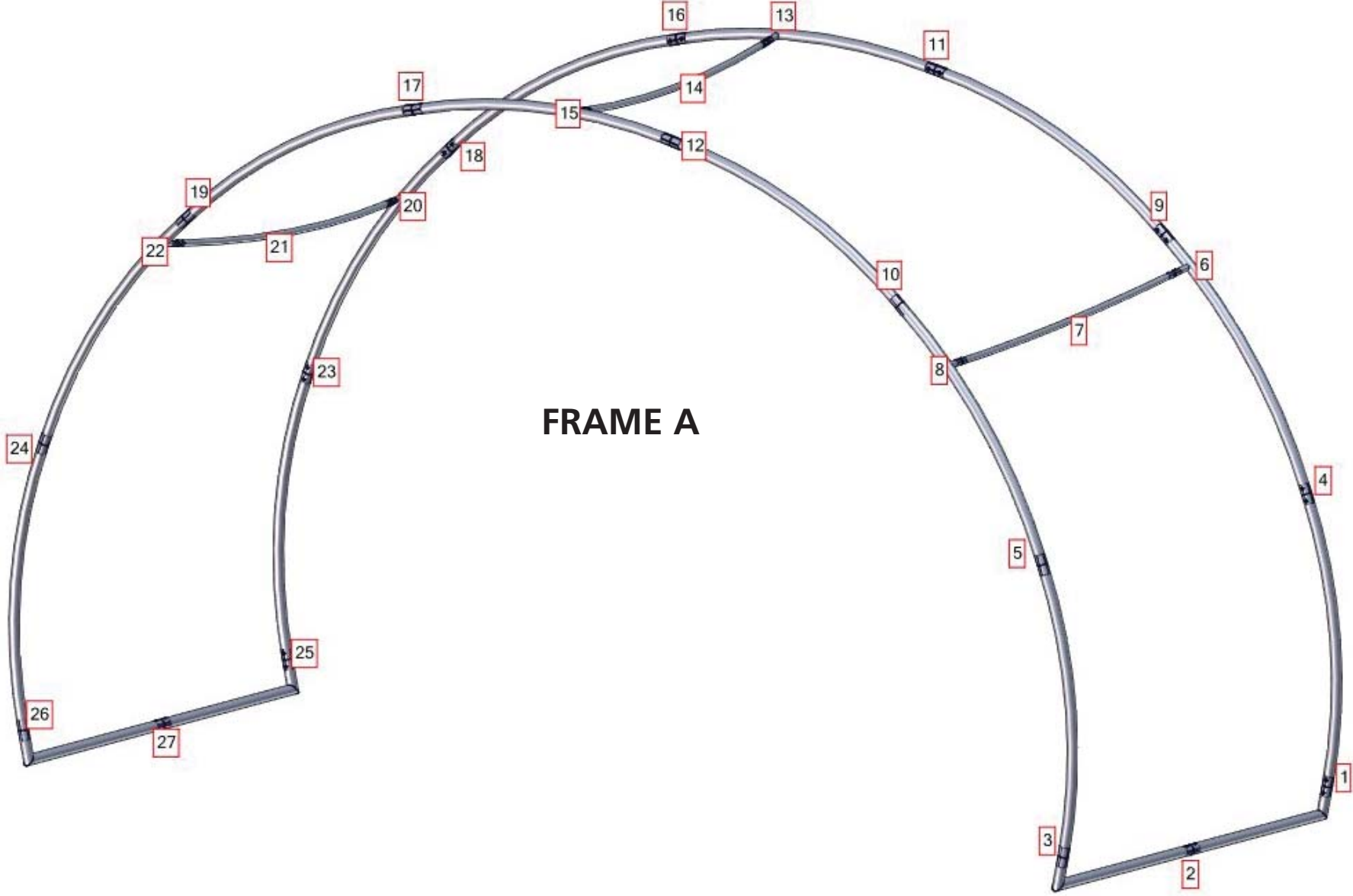

FRAME A

# Connection Methods

Formulate® structures use a number of different yet simple connection methods. Your kit will include one or more of the connection methods shown below. Steps within the Kit Assembly will reference a specific method for each connection point.

## Connection Method 1: ES30 / ES50 / ES75

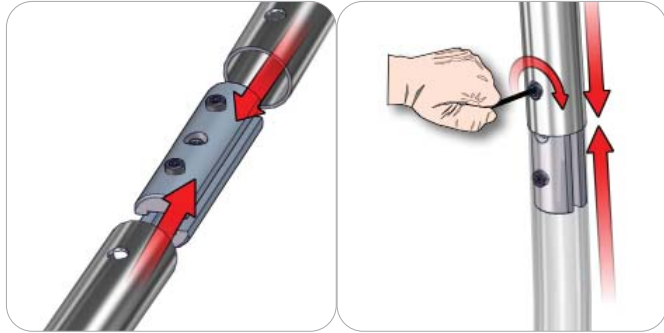

Compress the unlocked connector and slide one tube onto each end. Lock both screws carefully using your allen key tool. Be sure to lock securely, but do not overtighten.

## Connection Method 2: Snap Buttons & Swage

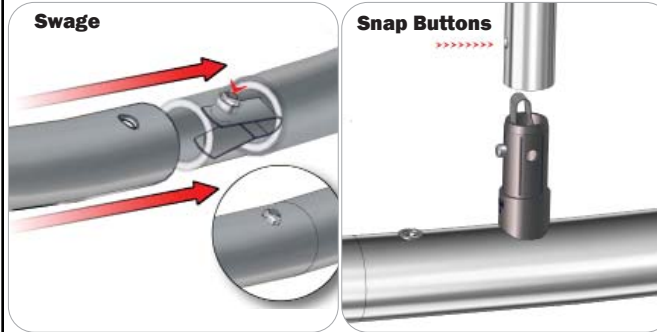

Locate the snap button on the connector or swage tube. Locate the hole on the corresponding tube. Press the snap button with your thumb and slide the tube and connector together so that the snap button snaps fully into the lock hole. To disassemble, press the snap button and pull apart.

## Connection Method 3: ES30-90B / ES30-I / ES30-C

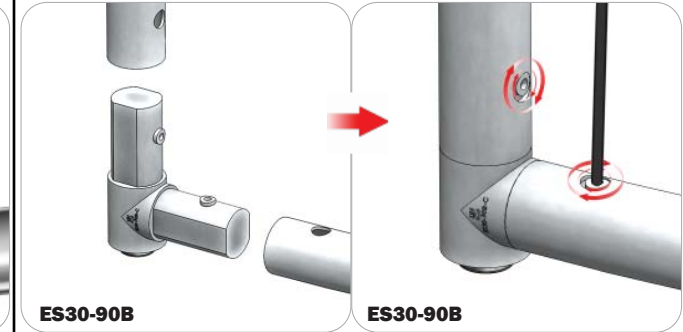

Compress one unlocked end of the connector and slide it through one tube end. Compress the other end of the connector and slide the second tube on. Lock both screws carefully using your allen key tool. Be sure to lock securely, but do not overtighten.

## Connection Method 4: Tube Clamps

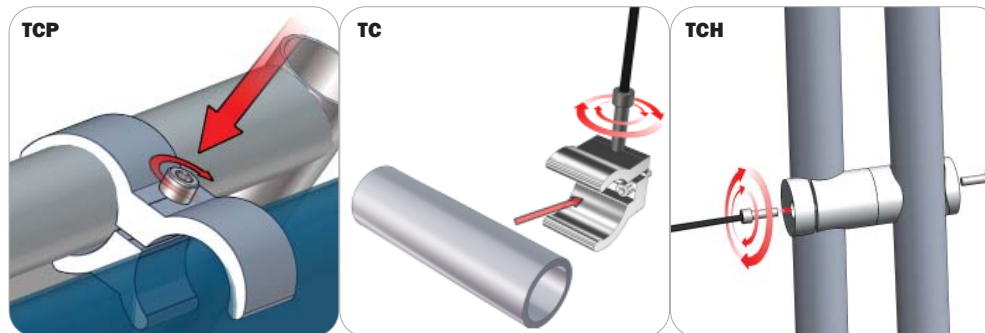

Be sure to fully assemble all frames before using clamps. With the clamp unlocked, place one tube of the first frame into the mouth of the clamp. Place the second tube (if applicable) into the second mouth of the clamp. With both frame's tubes in the clamp, be sure to lock securely, but do not overtighten.

# Kit Assembly

## Step by Step

### Step 1.

Gather the components necessary for assembling Frame A. Assemble in order according to the Labeling Diagram.

Please reference Connection Method 1 for more details.

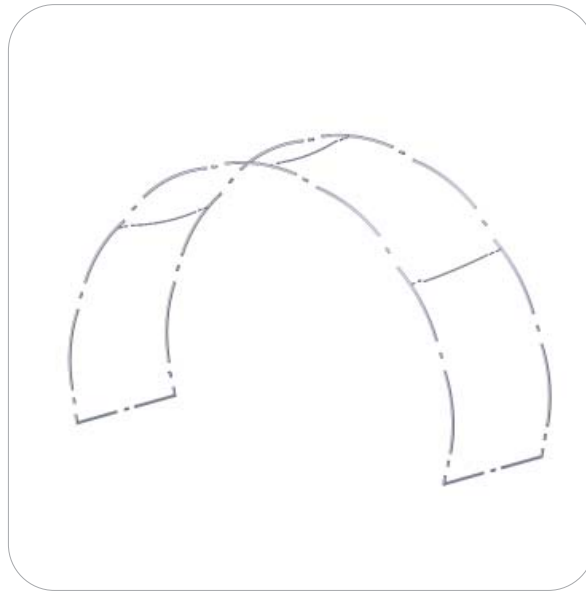
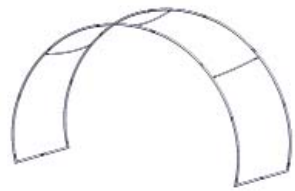

### Step 2.

With the pillowcase unzipped and Frame A laying on its side, encase Frame A by pulling the cover over the tubes.

Zipper located along the side of the graphic.

