

Formulate Designer Series 20' Backwall - Kit 09

FMLT-DS-20-09

Formulate® Designer Series 20ft displays have unique stylistic features and shapes, are portable and easy to assemble. The aluminum tube frame features snap-buttons and/or spigot connections and zipper pillowcase fabric graphics. All displays come in portable, wheeled transit cases. Simply pull the pillowcase fabric graphic(s) over the frame and zip.



features and benefits:

- Premium aluminum tube frames with snap button/ spigot assembly
- Accent frame attaches to backwall with simple clamps
- Easy to store and ship
- Quick to set up
- Two zipper pillowcase fabric graphics, one for the wall and one for the graphic ladder accent
- Weighted feet for added stability
- Lifetime limited hardware warranty against manufacturer defects

dimensions:

Hardware

Assembled unit:
227.89" w x 96" h x 36.27" d
5788mm(w) x 2438mm(h) x 921mm(d)

Approximate weight with cases:
135 lbs / 61.2 kgs

Shipping

Packing case(s):
2 OCE Cases

Shipping dimensions:
OCE: Expandable case length (l) may vary
40" - 66" l x 18" h x 18" d
1016mm-1677mm(l) x 458mm(h) x 458mm(d)

Approximate total shipping weight
(includes cases & graphics):
158 lbs / 71.7 kgs

Graphic

Refer to related graphic template for more information.

Visit:
www.exhibitors-handbook.com/graphic-templates

additional information:

Graphic material:
dye-sublimation zipper pillowcase fabric

We are continually improving and modifying our product range and reserve the right to vary the specifications without prior notice. All dimensions and weights quoted are approximate and we accept no responsibility for variance. E&OE. See Graphic Templates for graphic bleed specifications.

Included In Your Kit

Tools, Components, & Connectors



ALLEN KEY SET x1



ES50 x9



ES50-2W x1



TC-30-S x4



TCP-3050 x2

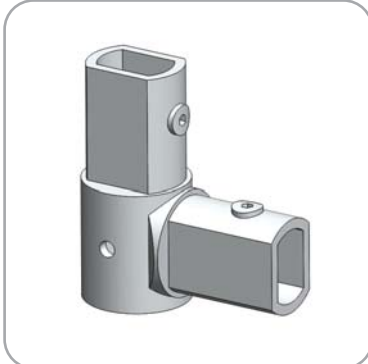

ES50-I-ES50-C-ASY x2



PLT-BP-LN114-S2-650 x2

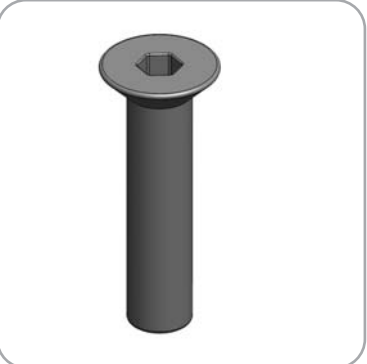

LN114-SCRW x2

Included In Your Kit

Tubes

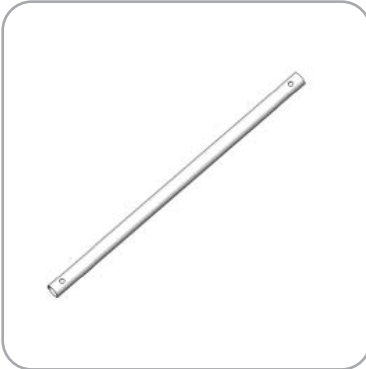

DS-20-09-A-T1 x3



DS-20-09-A-T2 x6



DS-20-09-A-T3 x1



DS-20-09-A-T4 x1



DS-20-09-A-T5 x1

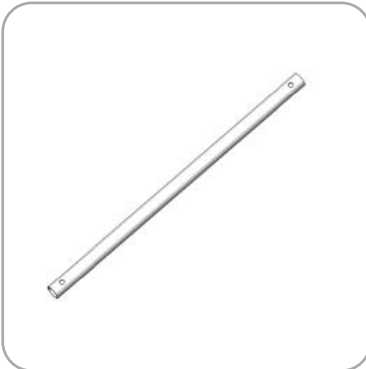

DS-20-09-A-T6 x5



DS-20-09-A-T7 x1



WL01-T1 x1



WL01-T2 x2



WL01-T3 x4

Graphics

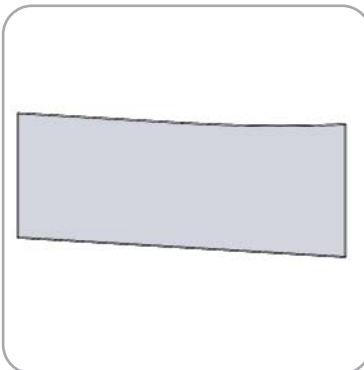

FMLT-DS-20-09-A-G x1



FMLT-DS-20-09-B-G x1

Exploded View

FMLT-DS-20-09

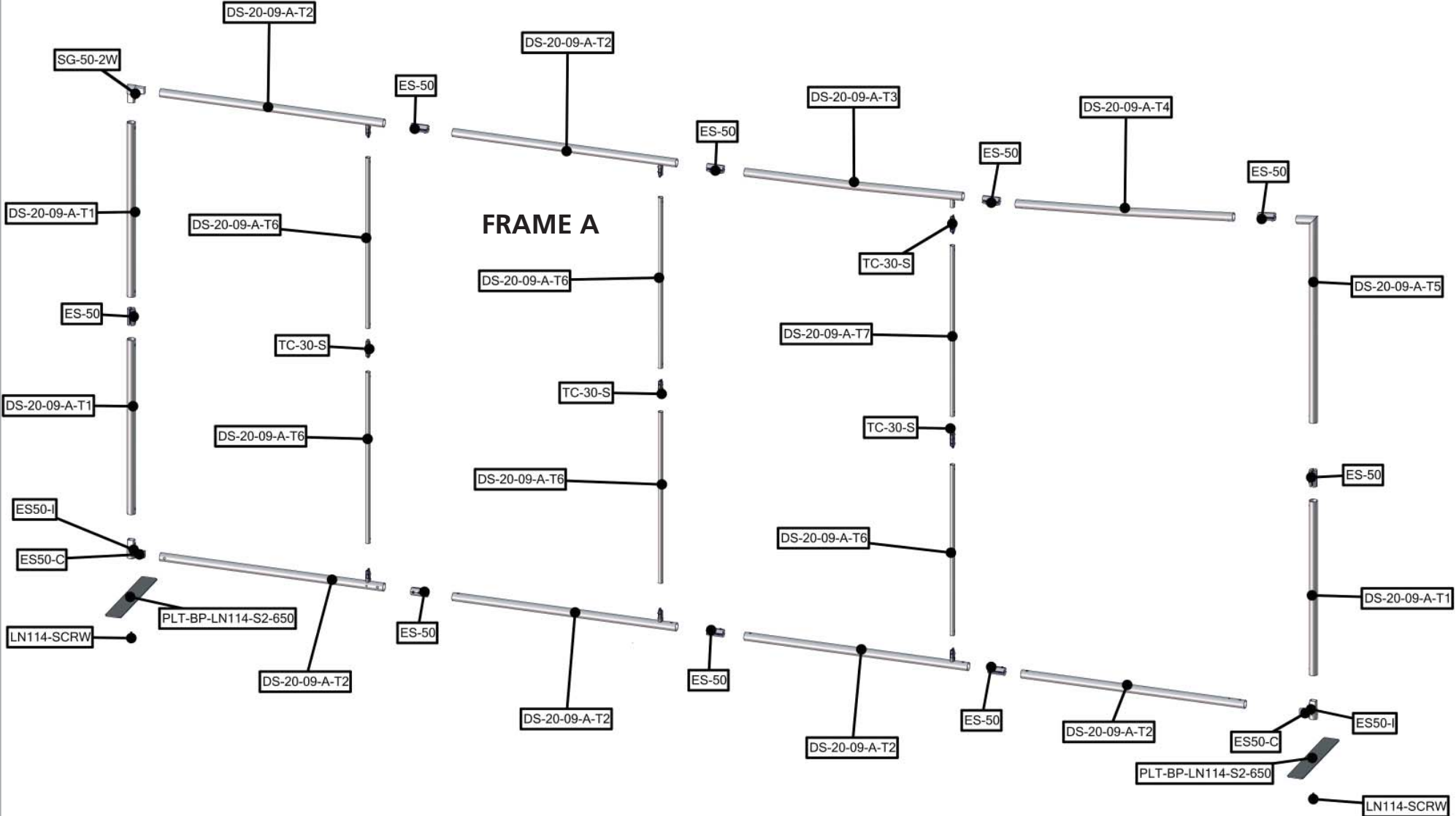

Exploded View

FMLT-DS-20-09

FRAME B

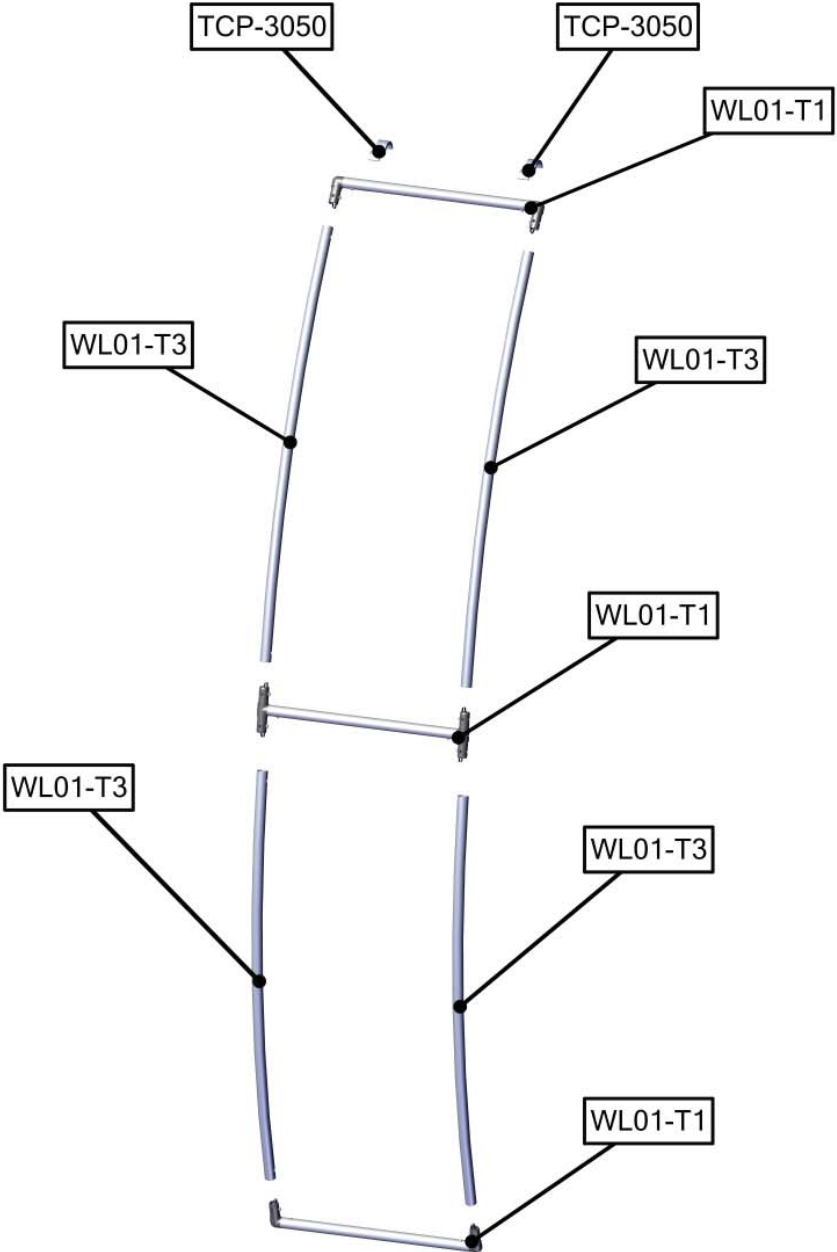

Labeling Diagram

FMLT-DS-20-09

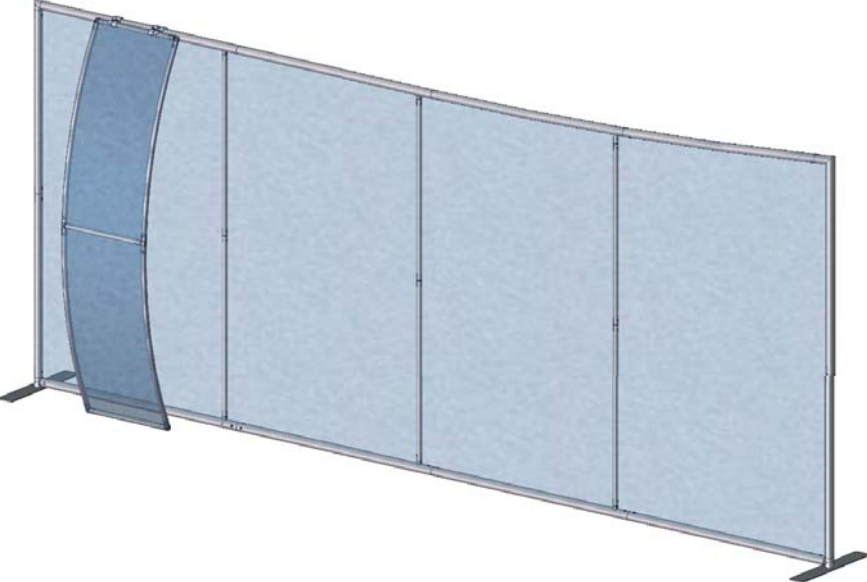
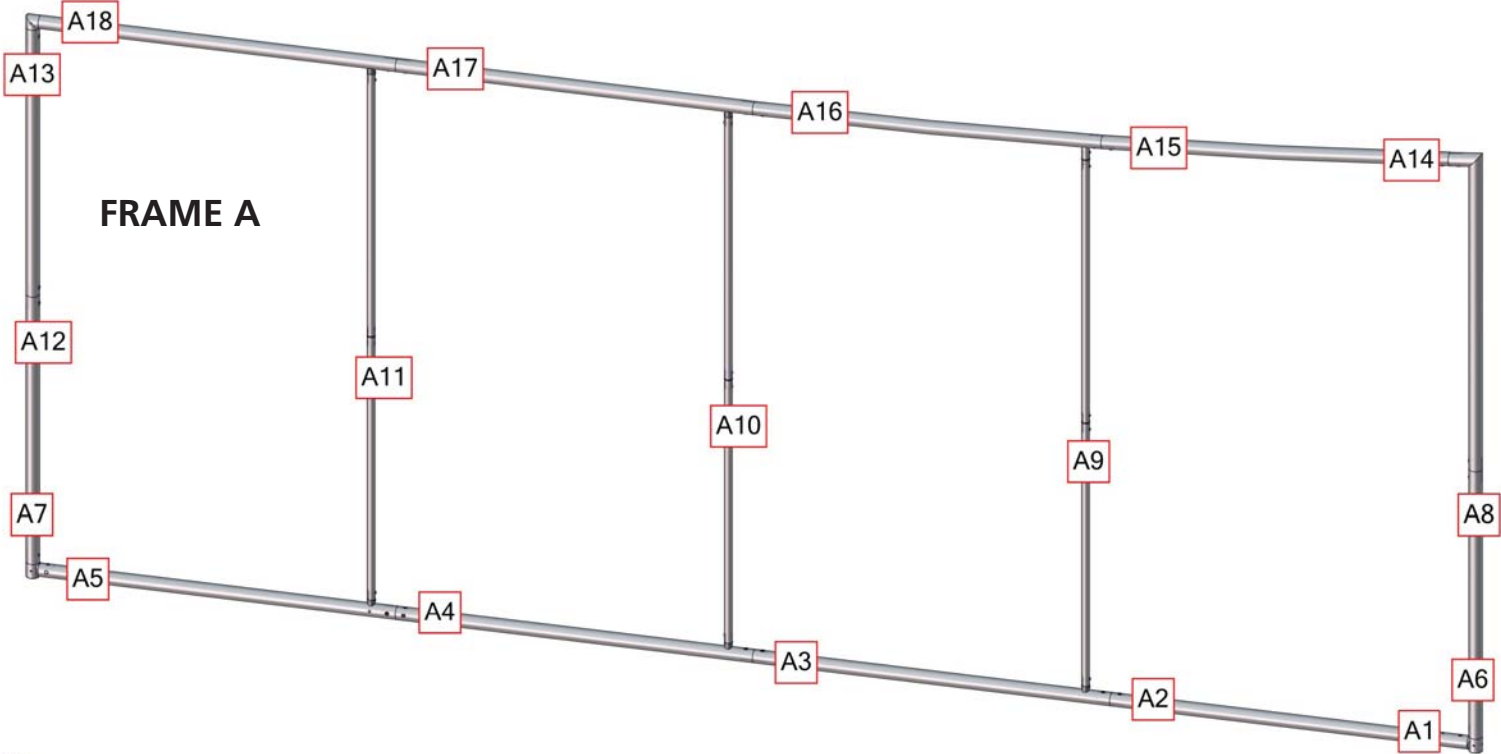

OVERHEAD VIEW

Labeling Diagram

FMLT-DS-20-09

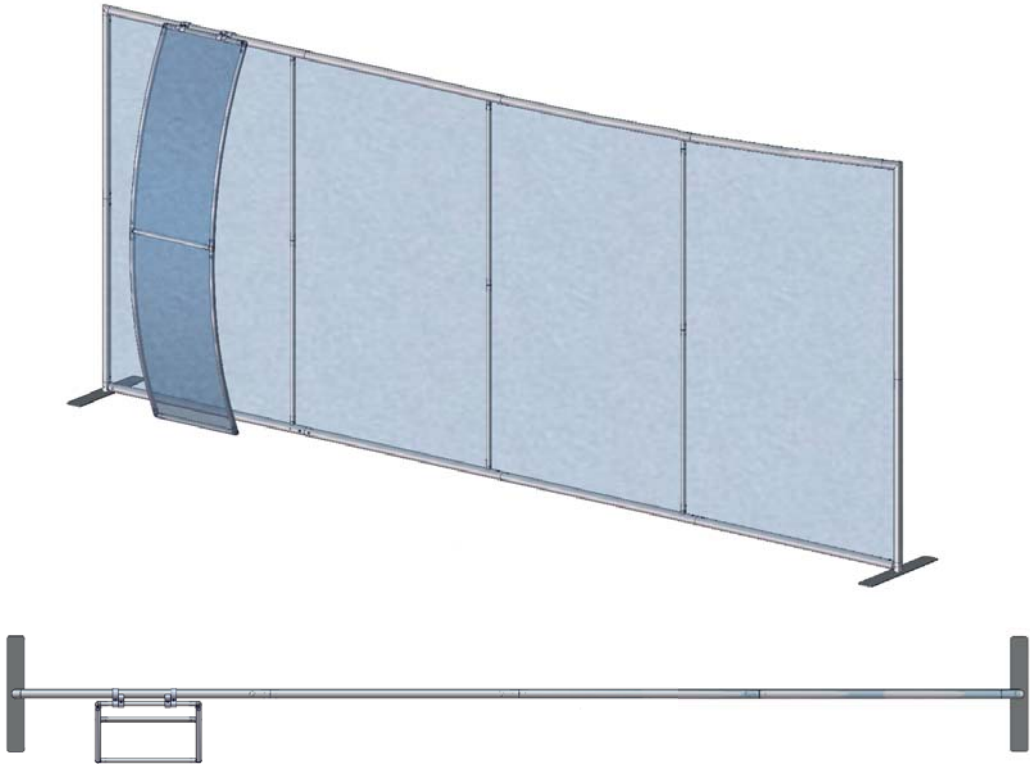

OVERHEAD VIEW

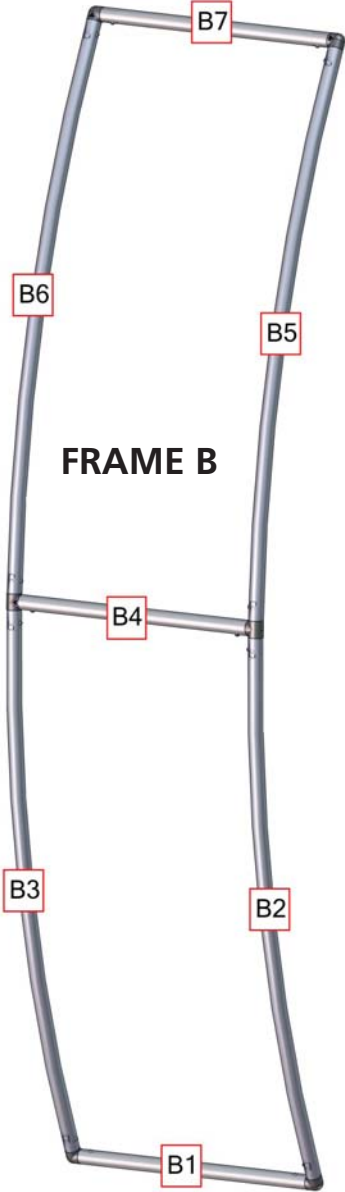

Connection Methods

Formulate™ structures use a number of different yet simple connection methods. Your kit will include one or more of the connection methods shown below. Steps within the Kit Assembly will reference a specific method for each connection point.

Connection Method 1: ES30 / ES50 / ES75

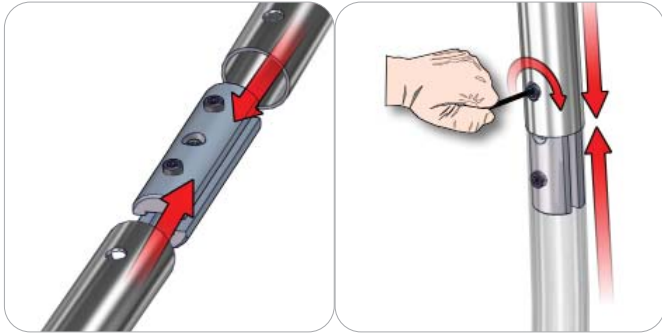

Compress the unlocked connector and slide one tube onto each end. Lock both screws carefully using your allen key tool. Be sure to lock securely, but do not overtighten.

Connection Method 2: Snap Buttons & Swage

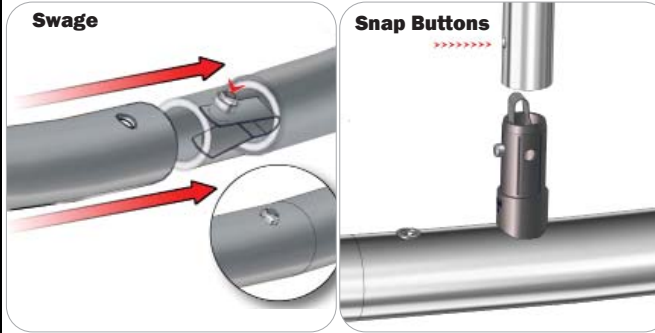

Locate the snap button on the connector or swage tube. Locate the hole on the corresponding tube. Press the snap button with your thumb and slide the tube and connector together so that the snap button snaps fully into the lock hole. To disassemble, press the snap button and pull apart.

Connection Method 3: ES30-90B / ES30-I / ES30-C

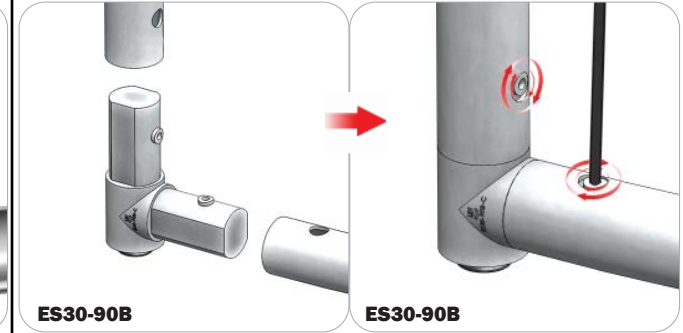

Compress one unlocked end of the connector and slide it through one tube end. Compress the other end of the connector and slide the second tube on. Lock both screws carefully using your allen key tool. Be sure to lock securely, but do not overtighten.

Connection Method 4: Tube Clamps

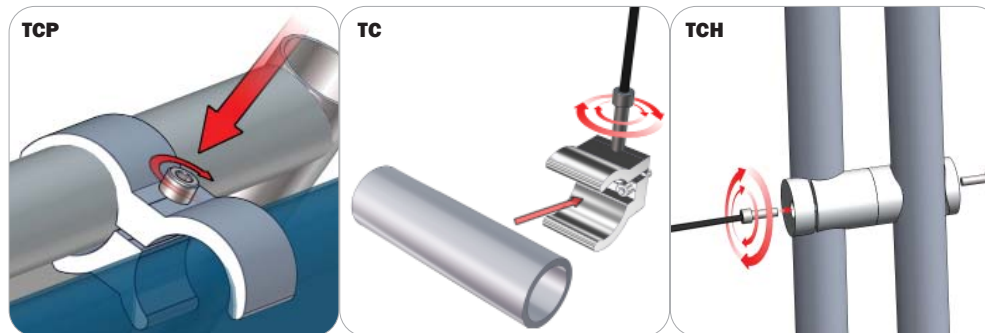

Be sure to fully assemble all frames before using clamps. With the clamp unlocked, place one tube of the first frame into the mouth of the clamp. Place the second tube (if applicable) into the second mouth of the clamp. With both frame's tubes in the clamp, be sure to lock securely, but do not overtighten.

Kit Assembly

Step by Step

Step 1.

Locate the components necessary for assembling Frame A. Assemble your frame in order according to the Labeling Diagram.

Please reference Connection Methods 1, 2 and 3 for more details.

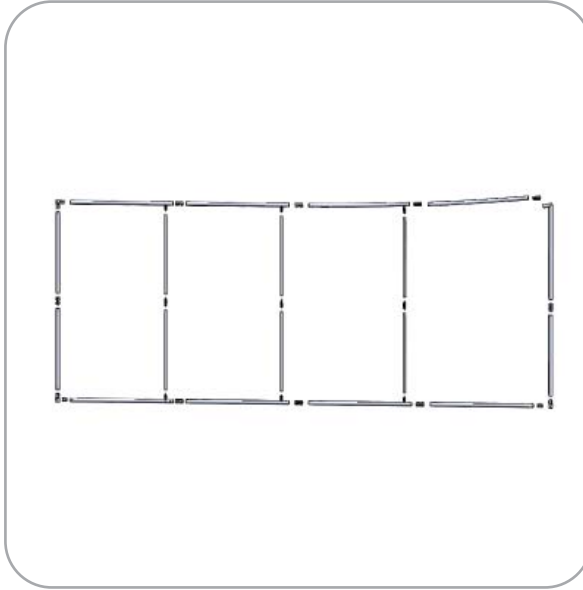

Step 2.

Locate the components necessary for assembling Frame B. Assemble your frame in order according to the Labeling Diagram.

Please reference Connection Method 2 for more details.

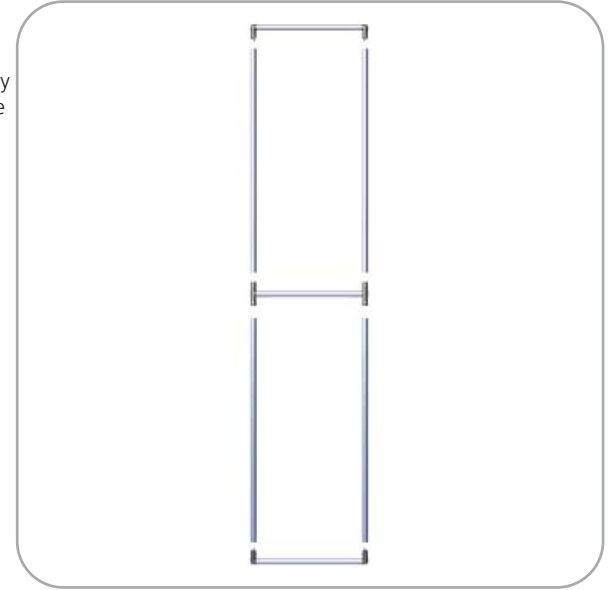

Step 3.

Fit graphic A onto Frame A. For ease of installation, pull the fabric cover over the top of the frame while the frame rests flat on the floor. Zip to enclose.

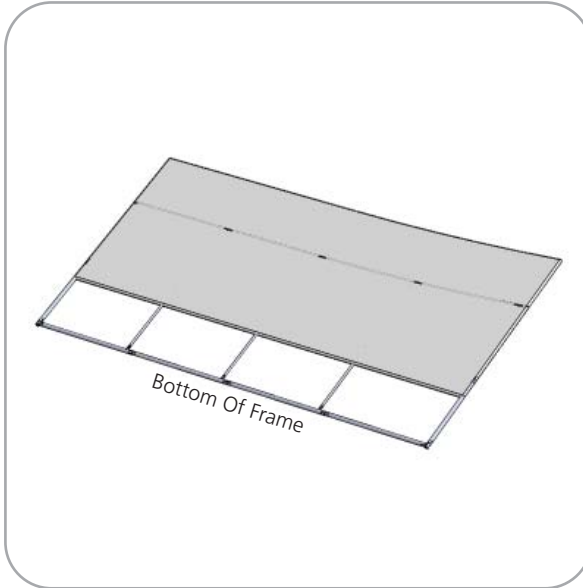

Step 4.

Fit graphic B onto Frame B. For ease of installation, pull the fabric cover over the top of the frame while the frame rests flat on the floor. Zip to enclose.

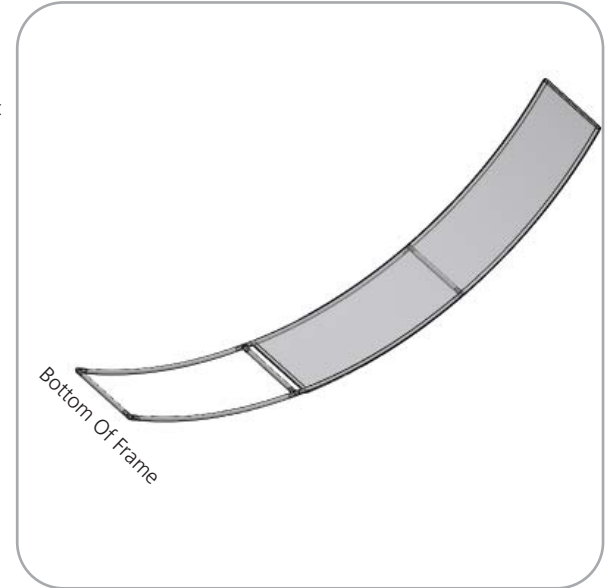

Kit Assembly

Step by Step

Step 5.

Locate both PLT-BP-LN114-S2-650, and LN114 Screws. Attach the pieces in order as shown on the figure to the right. Screw the LN114 screw through the bottom of the left and right ends of Frame A to lock in place.

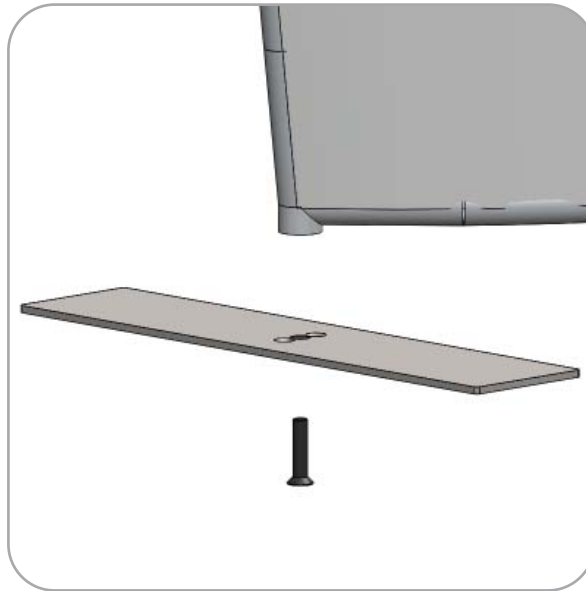
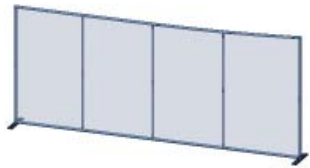

Step 6.

Locate your TCP-3050 clamps. Place the larger clamp onto the top of Frame A. Clip Frame B into the smaller clamps of the TCP-3050. Lock the connection using your allen key tool.

Please reference Connection Method 4 for more details.

