

Formulate Backwall Accent - 04S-R

FMLT-WBWA-04S-R

The Formulate™ Master Backwall Accent is an ideal accessory to connect to Formulate backwalls. It features a pillowcase fabric graphic and connects easily to create the appearance of one seamless display.

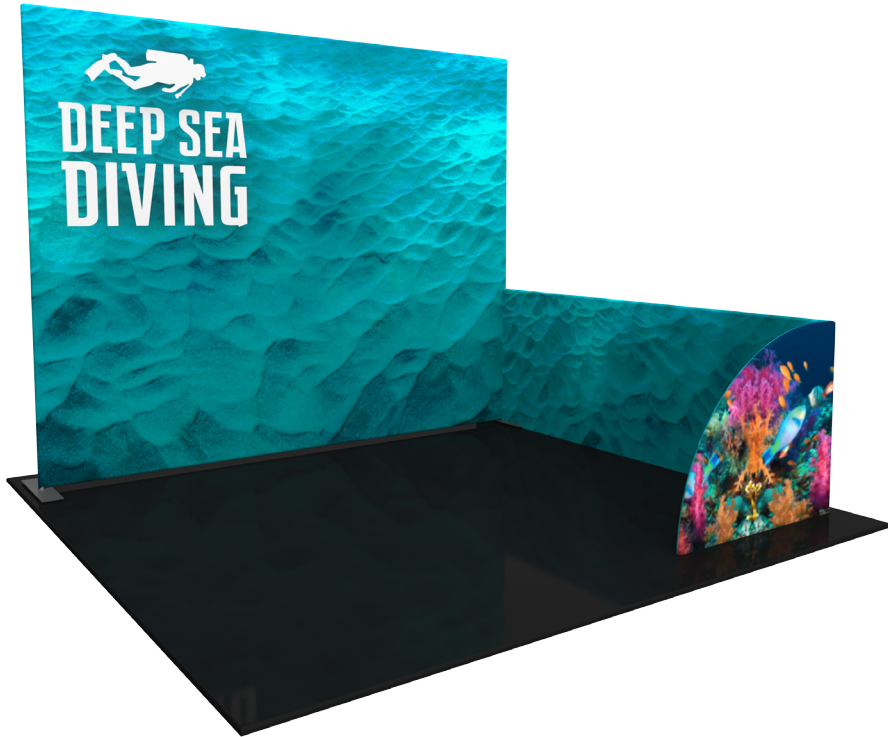

We are continually improving and modifying our product range and reserve the right to vary the specifications without prior notice. All dimensions and weights quoted are approximate and we accept no responsibility for variance. E&OE. See Graphic Templates for graphic bleed specifications.

features and benefits:

- Premium aluminum tube frames with snap button assembly
- Easy to store and ship
- Quick to set up
- One zipper pillowcase fabric graphic
- Lifetime limited hardware warranty against manufacturer defects

dimensions:

Hardware

Graphic

Assembled unit:

39.37" w x 35.43" h x 106.29" d
1000mm(w) x 900mm(h) x 2700mm(d)

Approximate weight with cases:
41lbs / 18.5kgs

Refer to related graphic template for more information.

Visit:
www.exhibitors-handbook.com/graphic-templates

Shipping

Packing case(s):
1 OCL Case

Shipping dimensions:
57" l x 19" h x 19" d
1448mm(l) x 483mm(h) x 483mm(d)

Approximate total shipping weight
(includes cases & graphics):
45lbs / 20.4kgs

additional information:

Graphic material:
dye-sublimation zipper pillowcase fabric

Backwall sold separately

Included In Your Kit

Tools, Components, & Connectors



ALLEN KEY SET x1



TC-30 x2



TC-30-T x4



TC-30-S x1

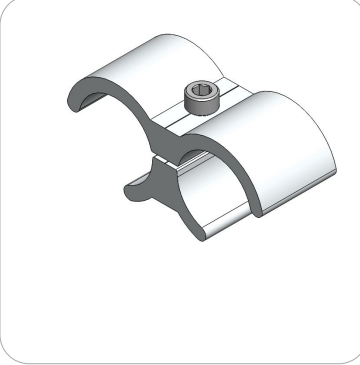

TCP-3030- x2

Graphics

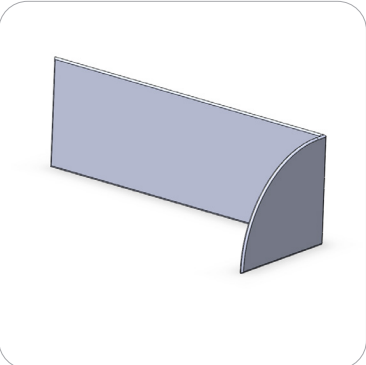

FMLT-WBWA-04S-R-G x1

Included In Your Kit

Tubes

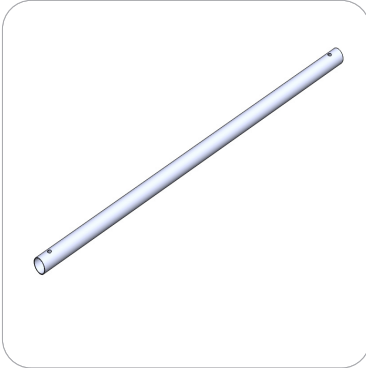

WBWA-04S-R-T1 x4

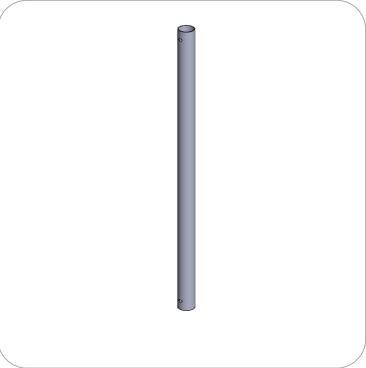

WBWA-04S-R-T2 x3



WBWA-04S-R-T3 x1

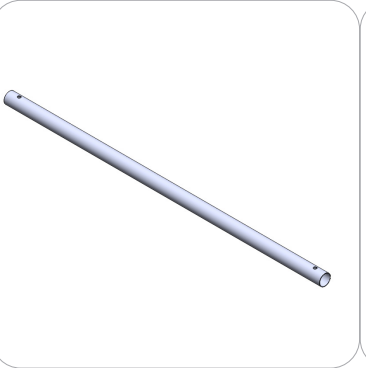

WBWA-04S-R-T4 x1

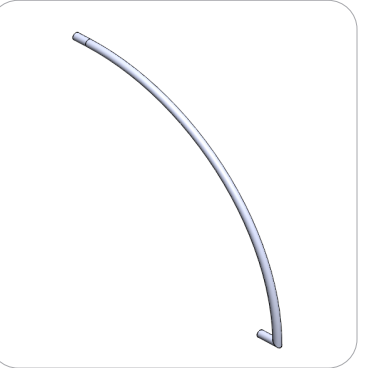

WBWA-04S-R-T5 x1

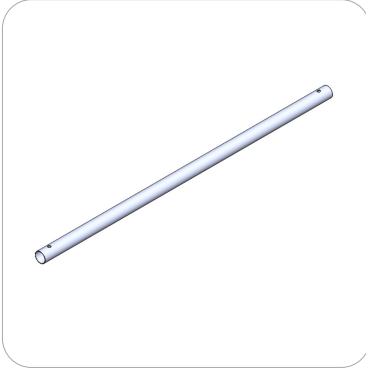

WBWA-04S-R-T6 x2

Exploded View

FMLT-WBWA-04S-R

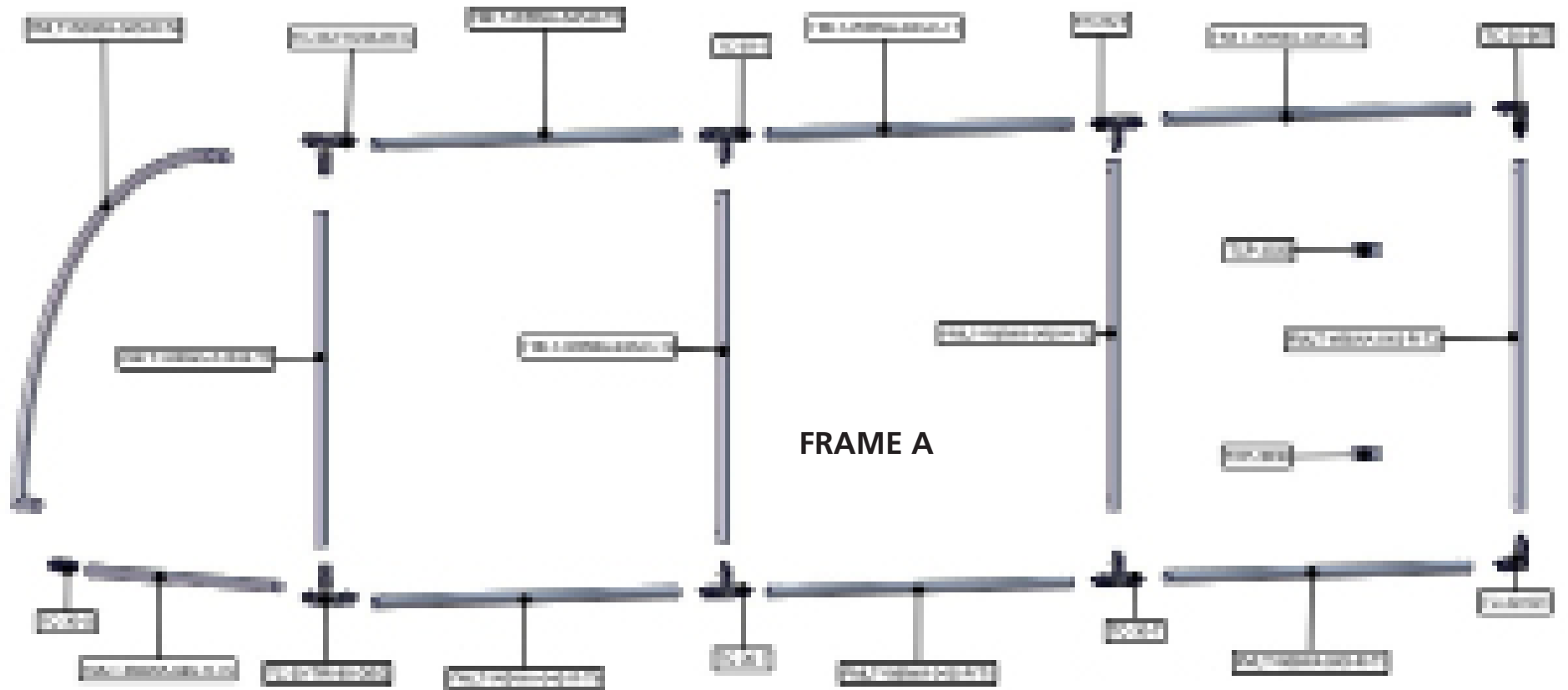

Labeling Diagram

FMLT-WBWA-04S-R

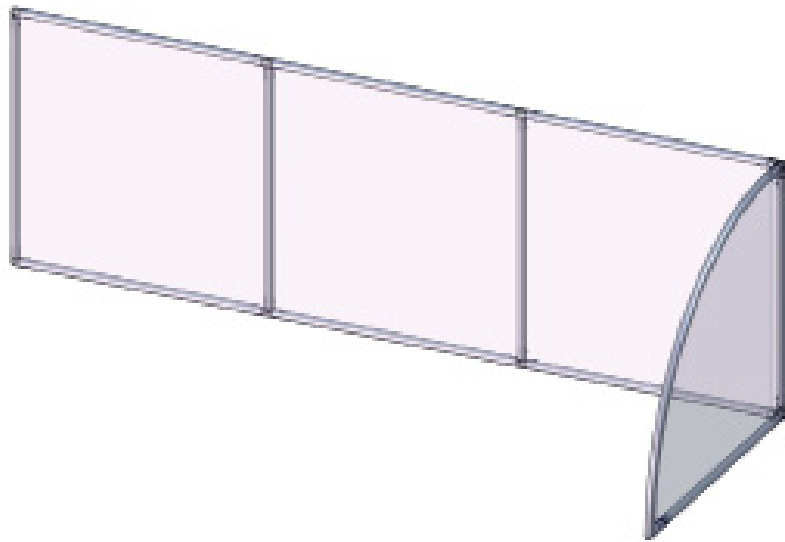
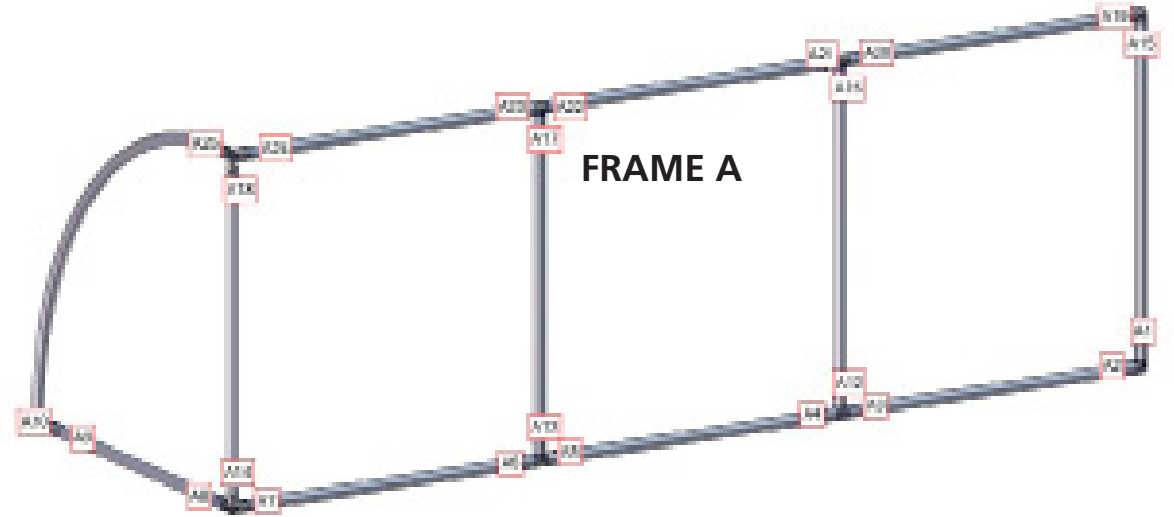

OVERHEAD VIEW

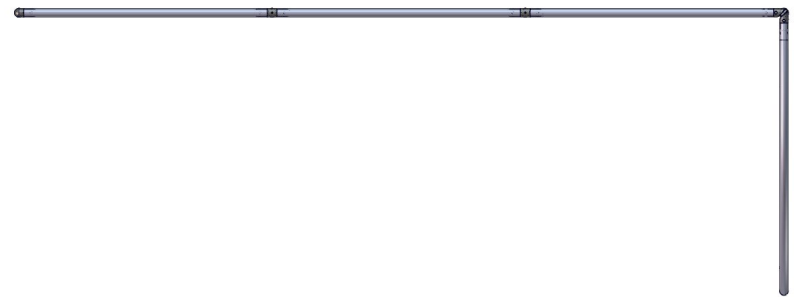

Connection Methods

Formulate™ structures use a number of different yet simple connection methods. Your kit will include one or more of the connection methods shown below. Steps within the Kit Assembly will reference a specific method for each connection point.

Connection Method 1: ES30 / ES50 / ES75

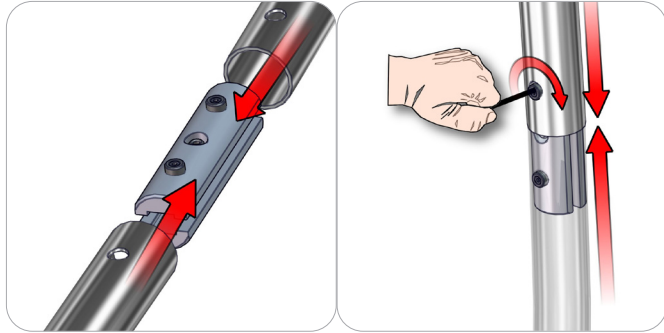

Compress the unlocked connector and slide one tube onto each end. Lock both screws carefully using your allen key tool. Be sure to lock securely, but do not overtighten.

Connection Method 2: Snap Buttons & Swage

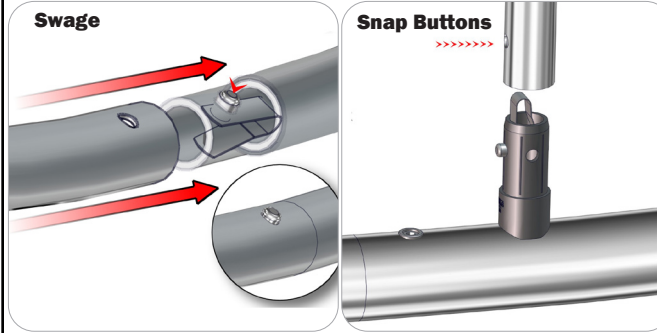

Locate the snap button on the connector or swage tube. Locate the hole on the corresponding tube. Press the snap button with your thumb and slide the tube and connector together so that the snap button snaps fully into the lock hole. To disassemble, press the snap button and pull apart.

Connection Method 3: ES30-90B / ES30-I / ES30-C

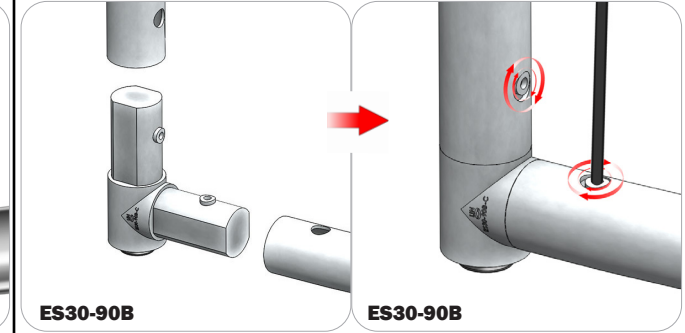

Compress one unlocked end of the connector and slide it through one tube end. Compress the other end of the connector and slide the second tube on. Lock both screws carefully using your allen key tool. Be sure to lock securely, but do not overtighten.

Connection Method 4: Tube Clamps

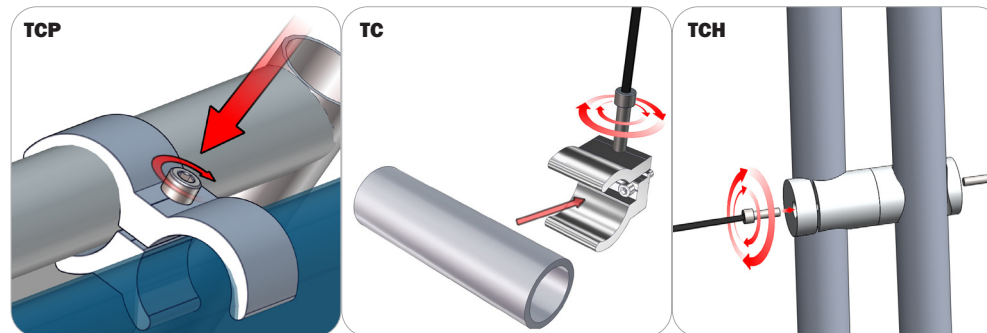

Be sure to fully assemble all frames before using clamps. With the clamp unlocked, place one tube of the first frame into the mouth of the clamp. Place the second tube (if applicable) into the second mouth of the clamp. With both frame's tubes in the clamp, be sure to lock securely, but do not overtighten.

Kit Assembly

Step by Step:

Step 1.

Locate the components necessary for assembling the frame. Assemble Frame A in order according to the Labeling Diagram.

Please reference Connection Method 2 for more details.

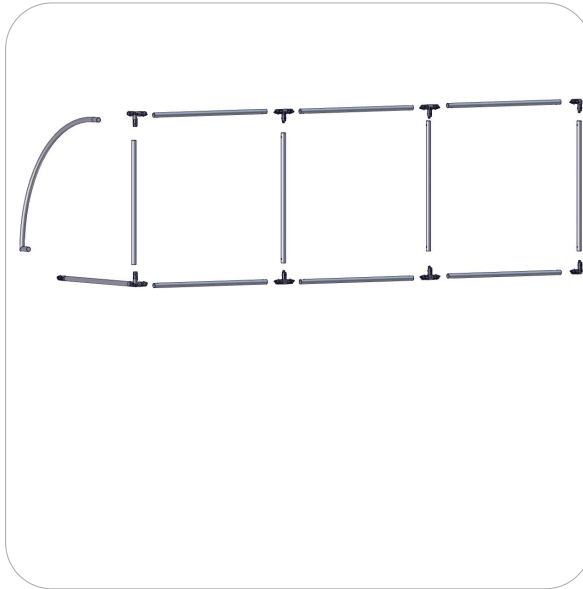
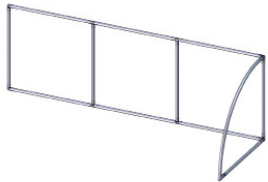

Step 2.

Apply the graphic pillowcase over the Frame A.

Zipper at the bottom of the frame.

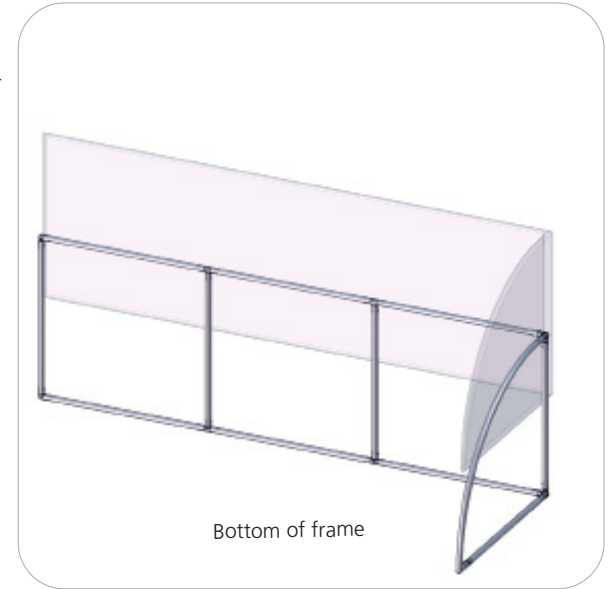
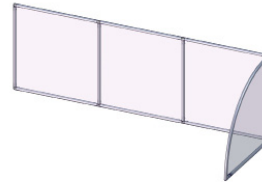

Step 3.

Connect the tube clamps onto Frame A and the backwall frame using the provided clamps.

Please reference Connection Method 4 for more information.

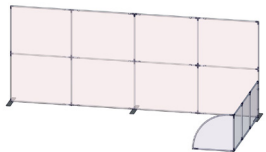

Step 4.

Setup is Complete.

Backwall structure sold separately.

