

Formulate Accent Ladder 09

FMLT-WL09

Formulate™ Master Accents enhance the functionality of many Formulate Master 10' and 20' backwalls and add more real estate for messaging too! With monitor supports, literature pockets, shelves, tables, counters, and more, you are sure to find the accent that best suits your needs. Side tables and graphic headers are also available.



We are continually improving and modifying our product range and reserve the right to vary the specifications without prior notice. All dimensions and weights quoted are approximate and we accept no responsibility for variance. E&OE. See Graphic Templates for graphic bleed specifications.

features and benefits:

- Premium aluminum tube frames with snap button assembly
- Easy to store and ship
- Quick to set up
- One zipper pillowcase fabric graphic
- Lifetime limited hardware warranty against manufacturer defects

dimensions:

Hardware

Assembled unit:
37.55"w x 92.69"h x 11.07"d
954mm(w) x 2354mm(h) x 281mm(d)

Approximate weight with cases:
36 lbs / 16.33kgs

Shipping

Packing case(s):
1 OCL Case

Shipping dimensions:
57"l x 19"w x 19"h
1448mm(l) x 483mm(w) x 483mm(h)

Approximate total shipping weight
(includes cases & graphics):
44lbs / 19.78kgs

Graphic

Refer to related graphic template for more information.

Visit:
www.exhibitors-handbook.com/graphic-templates

additional information:

Graphic material:
dye-sublimation zipper pillowcase fabric

Included In Your Kit

Tools, Components, & Connectors



ALLEN KEY SET x1



TC-30-A x4

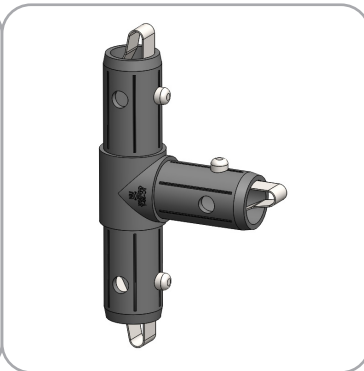

TC-30-T x2

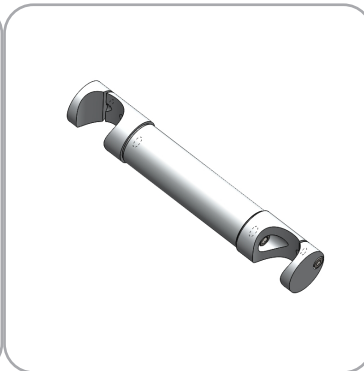

TCH-30-B2B-100 x2

Graphics

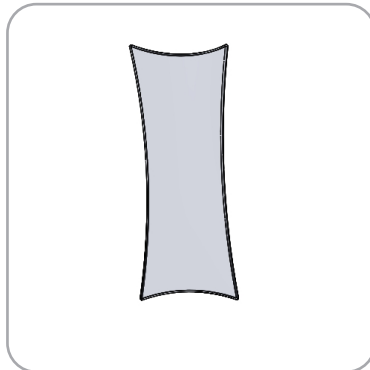

FMLF-WL-09-G x1

Included In Your Kit

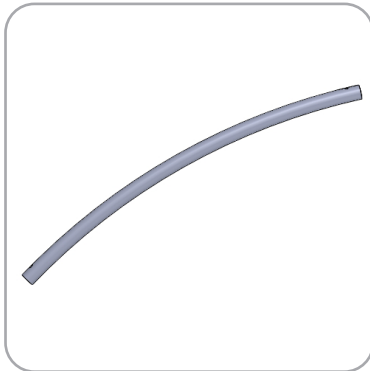

WL-09-T1 x1



WL-09-T2 x1

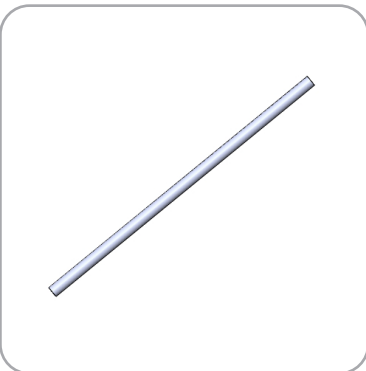

WL-09-T6 x1

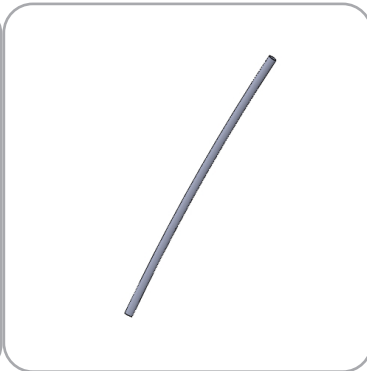

WL-09-T3 x1

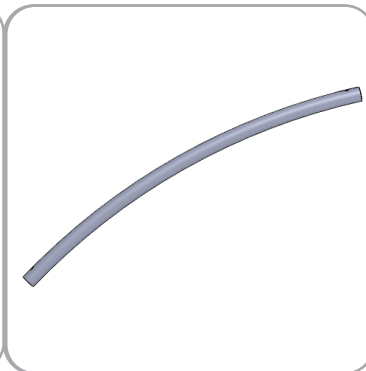

WL-09-T4 x1

Tubes

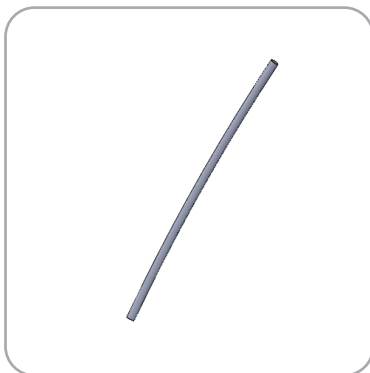

WL-09-T5 x2

Exploded View

FMLT-WL09

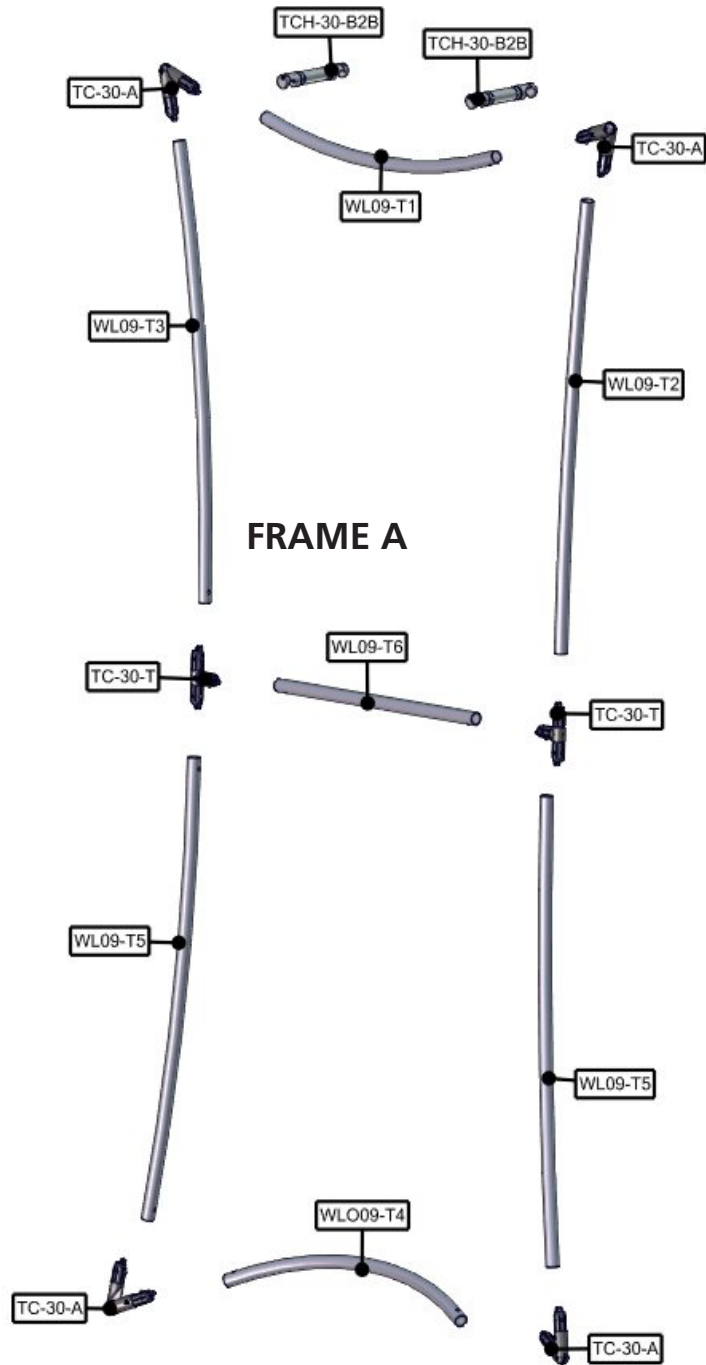

Connection Methods

Formulate™ structures use a number of different yet simple connection methods. Your kit will include one or more of the connection methods shown below. Steps within the Kit Assembly will reference a specific method for each connection point.

Connection Method 1: ES30 / ES50 / ES75

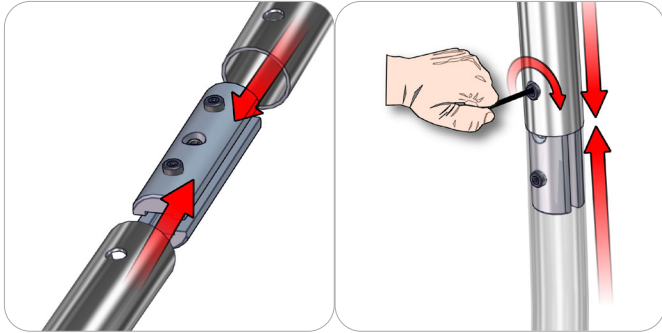

Compress the unlocked connector and slide one tube onto each end. Lock both screws carefully using your allen key tool. Be sure to lock securely, but do not overtighten.

Connection Method 2: Snap Buttons & Swage

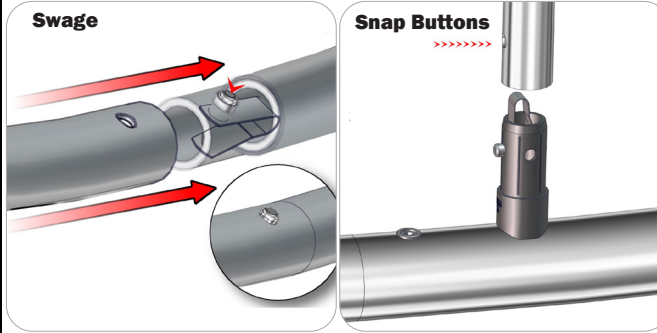

Locate the snap button on the connector or swage tube. Locate the hole on the corresponding tube. Press the snap button with your thumb and slide the tube and connector together so that the snap button snaps fully into the lock hole. To disassemble, press the snap button and pull apart.

Connection Method 3: ES30-90B / ES30-I / ES30-C

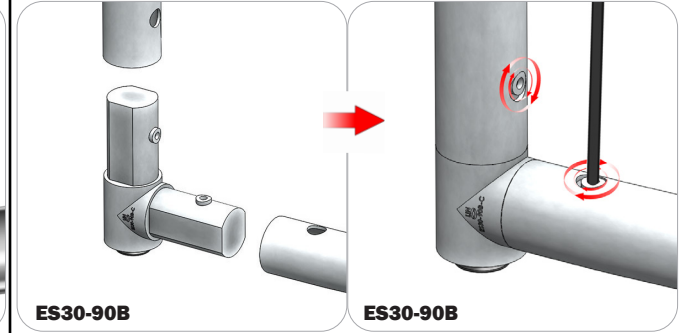

Compress one unlocked end of the connector and slide it through one tube end. Compress the other end of the connector and slide the second tube on. Lock both screws carefully using your allen key tool. Be sure to lock securely, but do not overtighten.

Connection Method 4: Tube Clamps

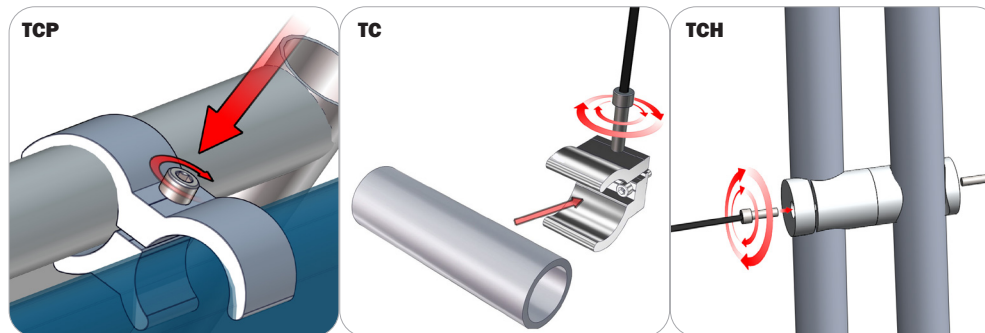

Be sure to fully assemble all frames before using clamps. With the clamp unlocked, place one tube of the first frame into the mouth of the clamp. Place the second tube (if applicable) into the second mouth of the clamp. With both frame's tubes in the clamp, be sure to lock securely, but do not overtighten.

Kit Assembly

Step by Step

Step 1.

Gather the components necessary for assembling Frame A.

Please reference Connection Method 2 for more details.



Step 2.

With the pillowcase unzipped, encase the top of Frame A by pulling the cover over the top tubes.

Zipper located on the bottom and right of the graphic.

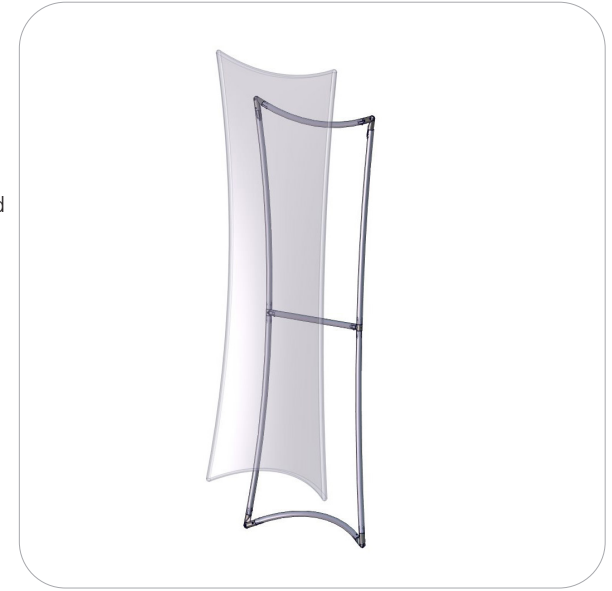

Step 3.

Connect the tube clamps onto Frame A and the backwall frame using the provided clamps.

Please reference Connection Method 4 for more information.



Step 4.

Setup is Complete.

Backwall structure sold separately.

