

Formulate 10' Vertical Curve - Kit 11

FMLT-WV10-11

Formulate® is a collection of sophisticated, ergonomically designed exhibit booths. Formulate combines state-of-the-art zipper pillowcase dye-sublimated fabric coverings with advanced lightweight aluminum structures to provide unique design, functionality, and style. The excellence of the Formulate line of displays, hanging structures and products is simply unmatched. Stretch fabric graphics are hand-sewn, durable and dry-cleanable.

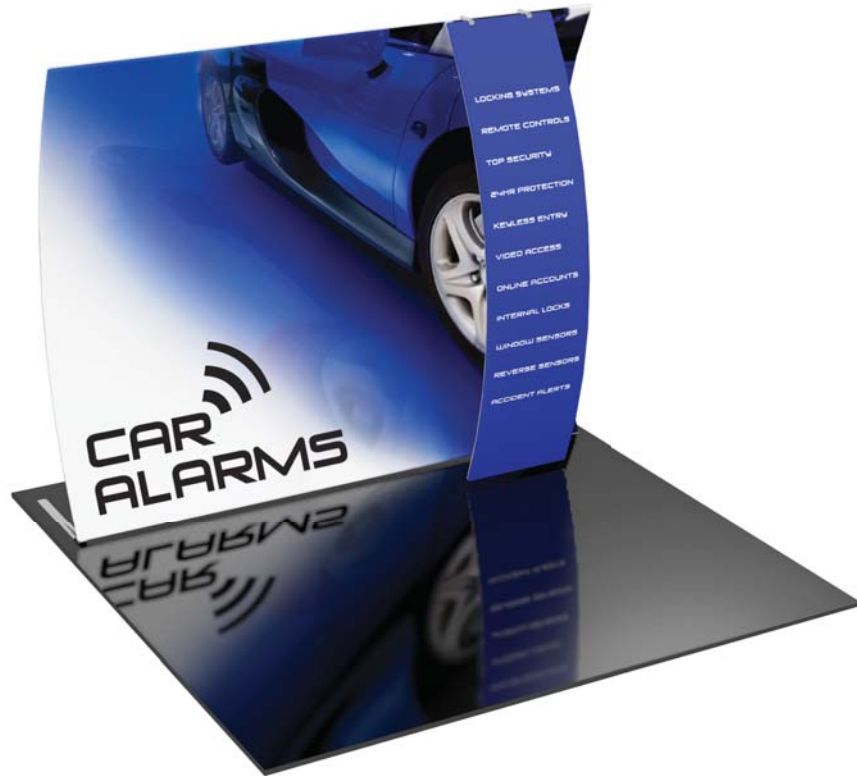

features and benefits:

- State-of-the-art 30mm aluminum tube frame with snap button assembly
- Easy to store and ship
- Quick to set up
- Kit includes: one frame, one dye-sublimated zipper pillowcase graphic, and one wheeled molded OCL storage case
- Lifetime hardware warranty against manufacturer defects

dimensions:

Hardware

Assembled unit:
114" w x 92" h x 38" d
2896mm(w) x 2337mm(h) x 965mm(d)

Approximate weight:
37 lbs / 17 kgs

Shipping

Shipping dimensions:

1 OCL

57" l x 19" h x 19" d
1448mm(l) x 483mm(h) x 483mm(d)

Approximate total shipping weight:
57 lbs / 26 kgs

Graphic

Refer to related graphic template for more information.

Visit:
www.exhibitors-handbook.com/graphic-templates

additional information:

Graphic material:
Dye-sublimation zipper pillowcase fabric

Optional Accessories:
Lumina 8-50 watt halogen lighting, literature pocket, stand-off graphic shelf, graphic header, larger freight cases

When included in a larger kit, a different packaging solution will be listed to accommodate all contents of the kit. Individual packaging no longer provided.

We are continually improving and modifying our product range and reserve the right to vary the specifications without prior notice. All dimensions and weights quoted are approximate and we accept no responsibility for variance. E&OE. See Graphic Templates for graphic bleed specifications.

Included In Your Kit

Kits, Accents & Accessories



FMLT-WV10-01 x1



FMLT-WL01 x1

Graphics

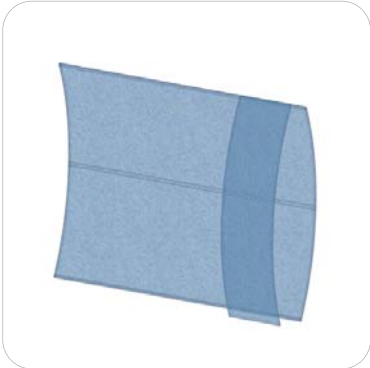

FMLT-WV10-11-G x1

Suggested Kit Layout

FMLT-WV10-11

FMLT-WL01

FMLT-WV10-01

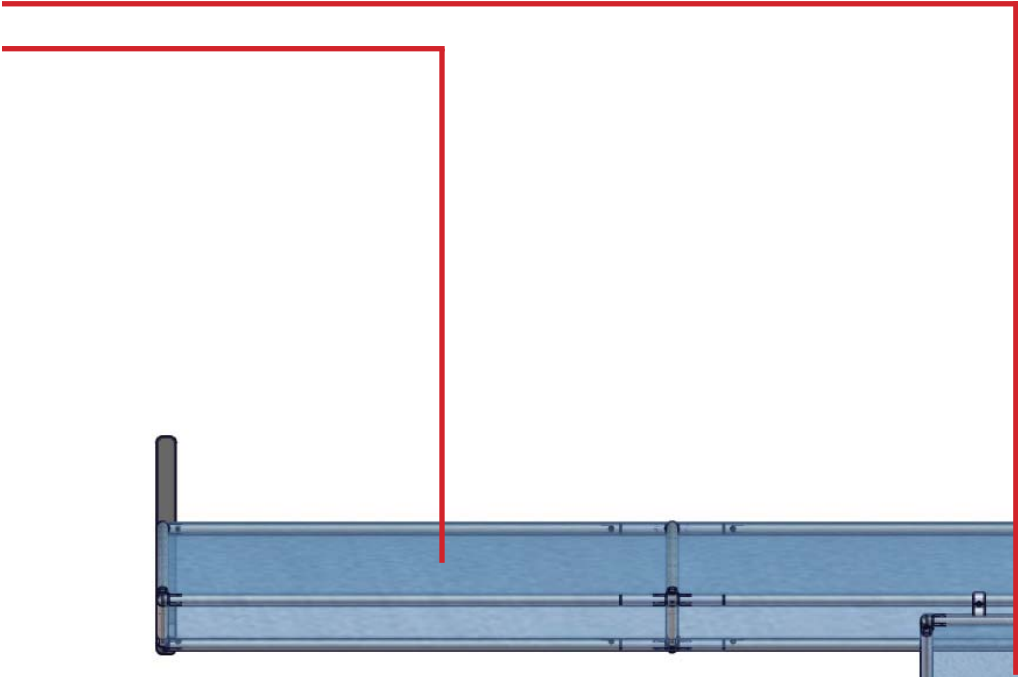

Formulate 10' Vertical Curve - Kit 1

FMLT-WV10-01

Formulate® is a collection of sophisticated, ergonomically designed exhibit booths. Formulate combines state-of-the-art zipper pillowcase dye-sublimated fabric coverings with advanced lightweight aluminum structures to provide unique design, functionality, and style. The excellence of the Formulate line of displays, hanging structures and products is simply unmatched. Stretch fabric graphics are hand-sewn, durable and dry-cleanable.



features and benefits:

- State-of-the-art 30mm aluminum tube frame with snap button assembly
- Easy to store and ship
- Quick to set up
- Kit includes: one frame, one dye-sublimated zipper pillowcase graphic, and one wheeled molded OCL storage case
- Lifetime hardware warranty against manufacturer defects

dimensions:

Hardware

Assembled unit:
114"w x 92"h x 24"d
2896mm(w) x 2337mm(h) x 610mm(d)

Approximate weight:
29 lbs / 13 kgs

Shipping

Shipping dimensions:

1 OCL

57"l x 19"h x 19"d
1448mm(l) x 483mm(h) x 483mm(d)

Approximate total shipping weight:
49 lbs / 22 kgs

Graphic

Refer to related graphic template for more information.

Visit:
www.exhibitors-handbook.com/graphic-templates

additional information:

Graphic material:
Dye-sublimation zipper pillowcase fabric

Optional Accessories:
Lumina 8-50 watt halogen lighting, literature pocket, stand-off graphic shelf, graphic header, larger freight cases

When included in a larger kit, a different packaging solution will be listed to accommodate all contents of the kit. Individual packaging no longer provided.

We are continually improving and modifying our product range and reserve the right to vary the specifications without prior notice. All dimensions and weights quoted are approximate and we accept no responsibility for variance. E&OE. See Graphic Templates for graphic bleed specifications.

Included In Your Kit

Tools, Components, & Connectors



ALLEN KEY SET x1



LN114-SCRW x2



PLT-BP-WVC-STD x2



TC-30-90T x2

Graphics



FMLT-WV10-01-G x1

Included In Your Kit



WV10-01-T1 x6



WV10-01-T2 x4



WV10-01-T4 x1



WV10-01-T5 x1



WV10-01-T7 x1

Tubes



WV10-01-T2-L x1



WV10-01-T2-R x1

Exploded View

FMLT-WV10-01

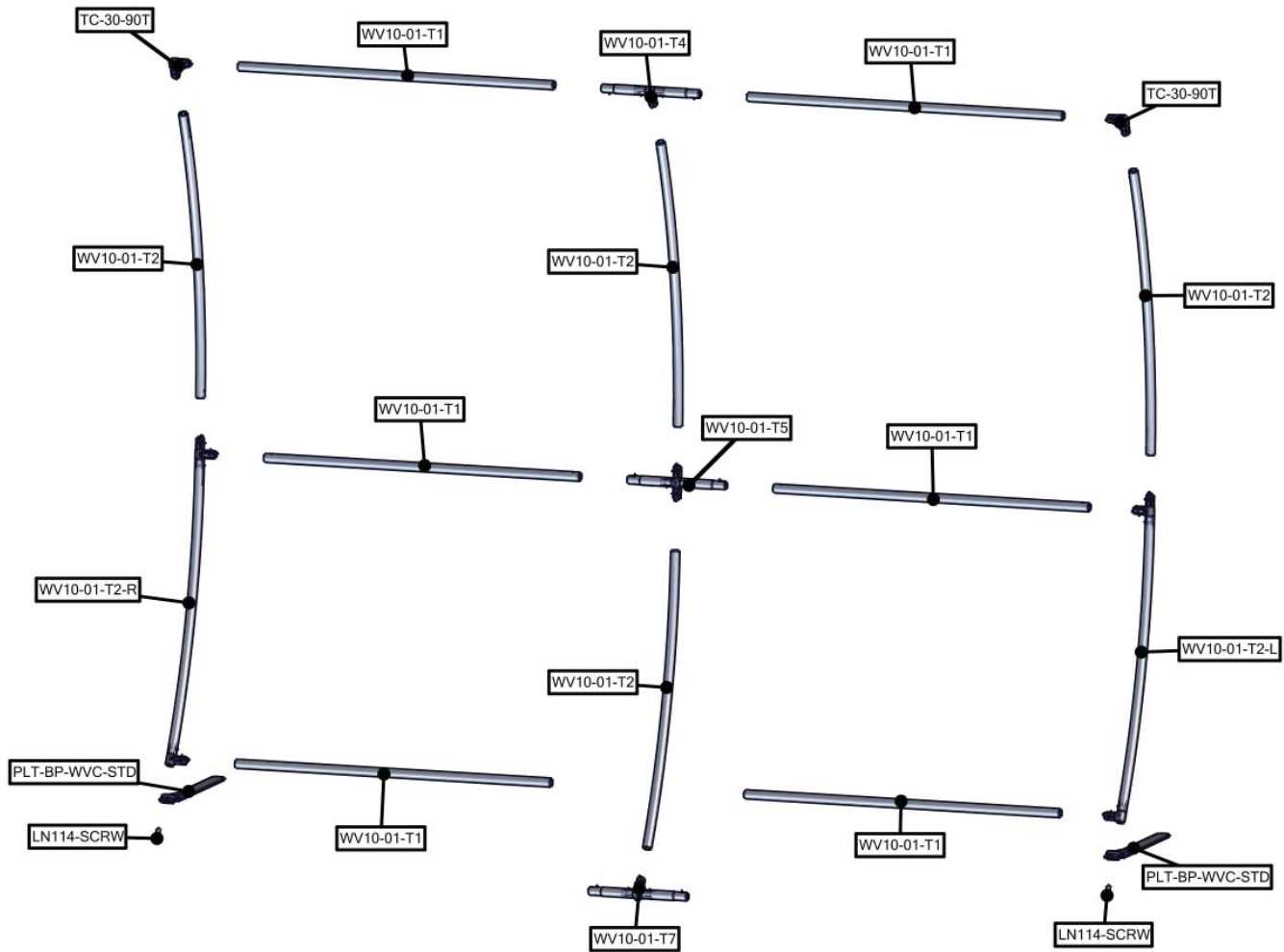

Labeling Diagram

FMLT-WV10-01

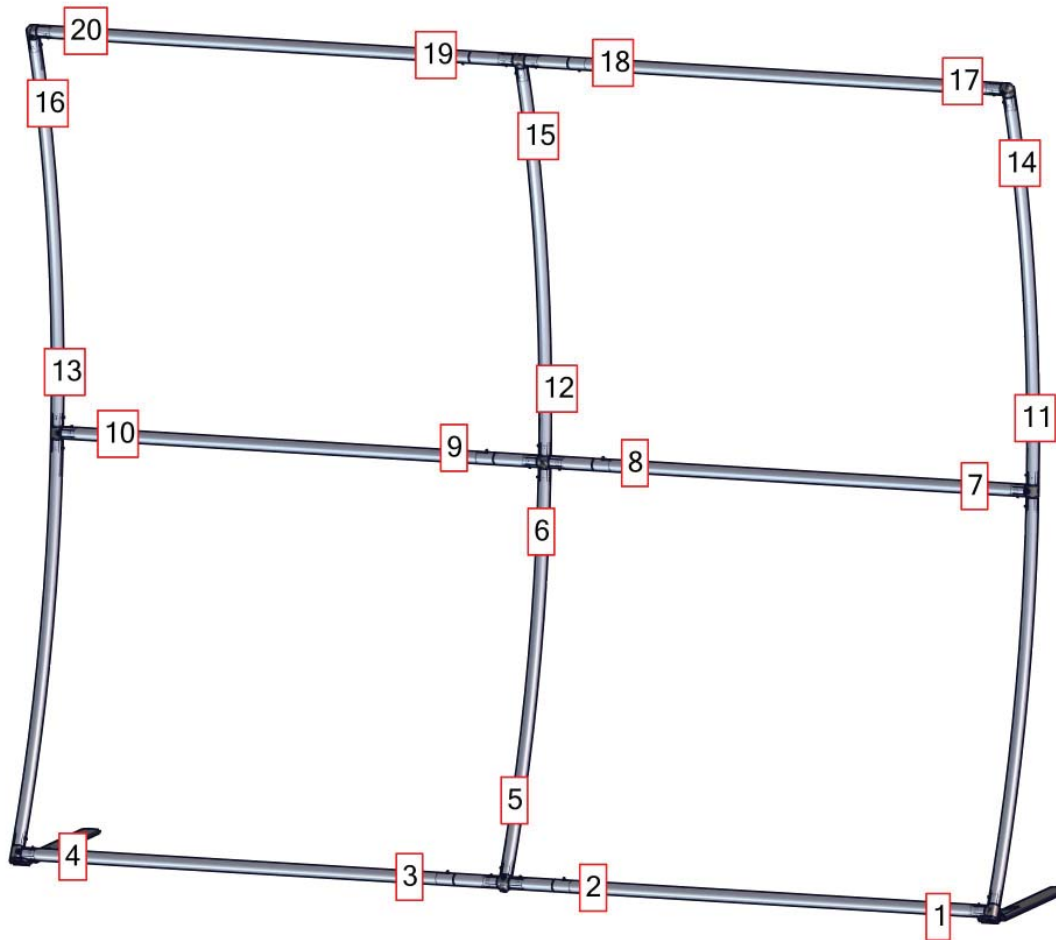

Connection Methods

Formulate® structures use a number of different yet simple connection methods. Your kit will include one or more of the connection methods shown below. Steps within the Kit Assembly will reference a specific method for each connection point.

Connection Method 1: ES30 / ES50 / ES75

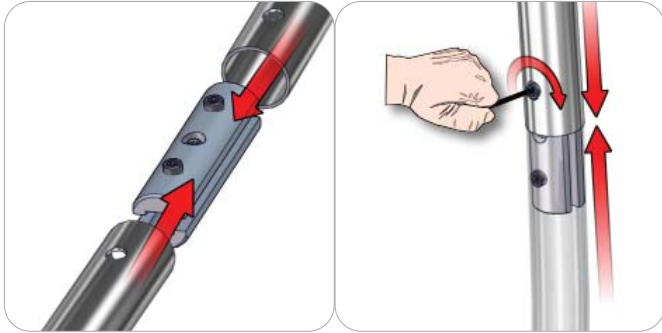

Compress the unlocked connector and slide one tube onto each end. Lock both screws carefully using your allen key tool. Be sure to lock securely, but do not overtighten.

Connection Method 2: Snap Buttons & Swage

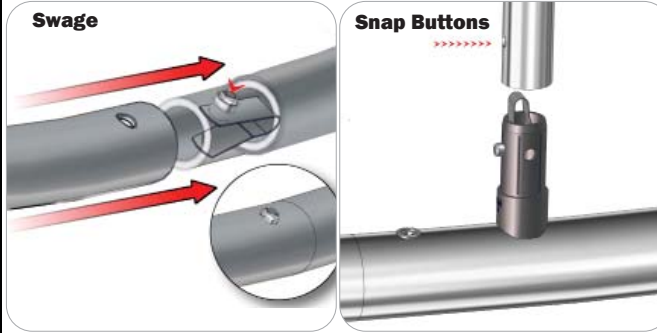

Locate the snap button on the connector or swage tube. Locate the hole on the corresponding tube. Press the snap button with your thumb and slide the tube and connector together so that the snap button snaps fully into the lock hole. To disassemble, press the snap button and pull apart.

Connection Method 3: ES30-90B / ES30-I / ES30-C

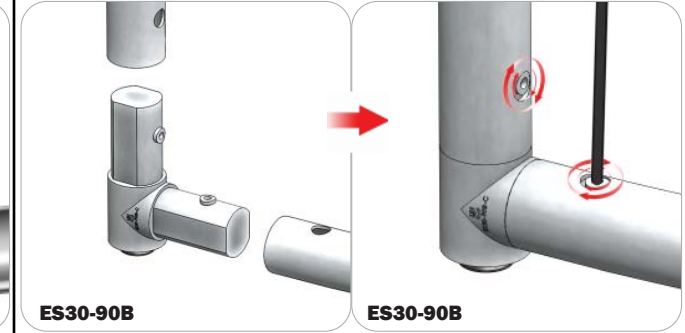

Compress one unlocked end of the connector and slide it through one tube end. Compress the other end of the connector and slide the second tube on. Lock both screws carefully using your allen key tool. Be sure to lock securely, but do not overtighten.

Connection Method 4: Tube Clamps

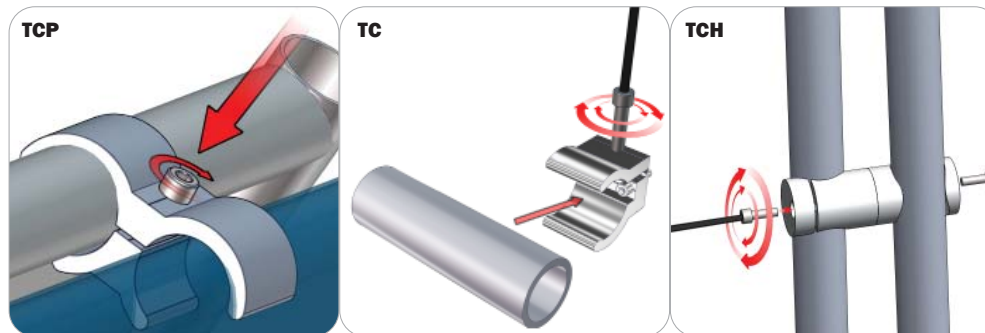

Be sure to fully assemble all frames before using clamps. With the clamp unlocked, place one tube of the first frame into the mouth of the clamp. Place the second tube (if applicable) into the second mouth of the clamp. With both frame's tubes in the clamp, be sure to lock securely, but do not overtighten.

Kit Assembly

Step by Step

Step 1.

Locate the components necessary for assembling the frame. Assemble your frame in order according to the Labeling Diagram.

Please reference Connection Method 2 for more details.

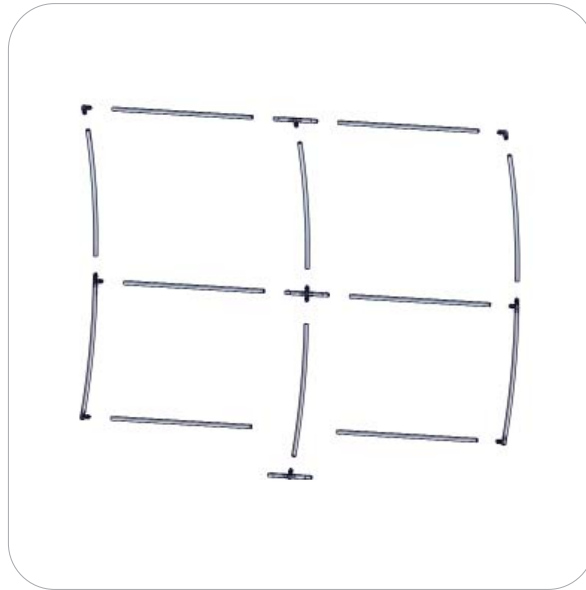
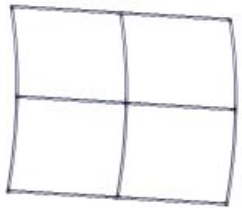

Step 2.

Apply the pillowcase graphic around the frame from the top and zip along the bottom edge.

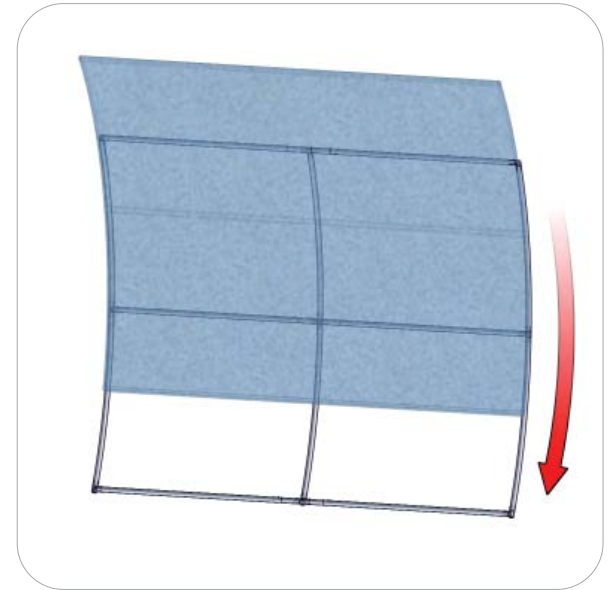
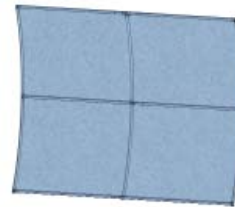

Step 3.

Using the provided allen key tool, tighten the screws to the bottom of frame. Make sure to fasten securely, but do not overtighten.

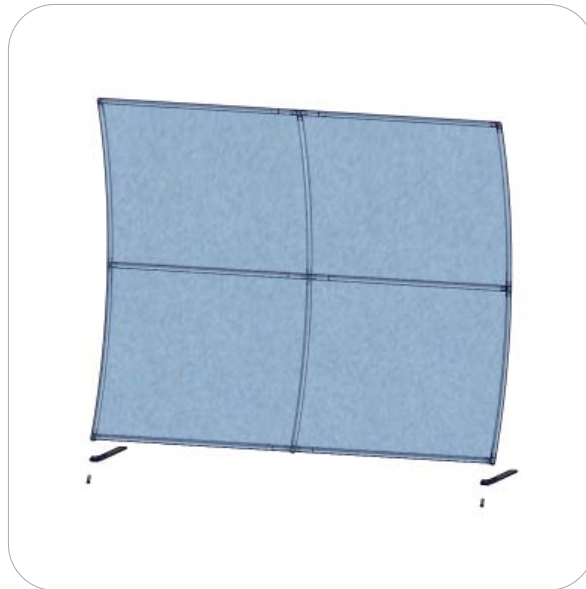

Step 4.

Setup is Complete.



Formulate Accent - 01

FMLT-WL01

Formulate® accents enhance the functionality of any 10ft or 20ft backwall and add more real estate for messaging too! You are sure to find the accent that best fits your needs with monitor supports, literature pockets, shelves, tables, counters and more. Side tables and graphic headers are also available.

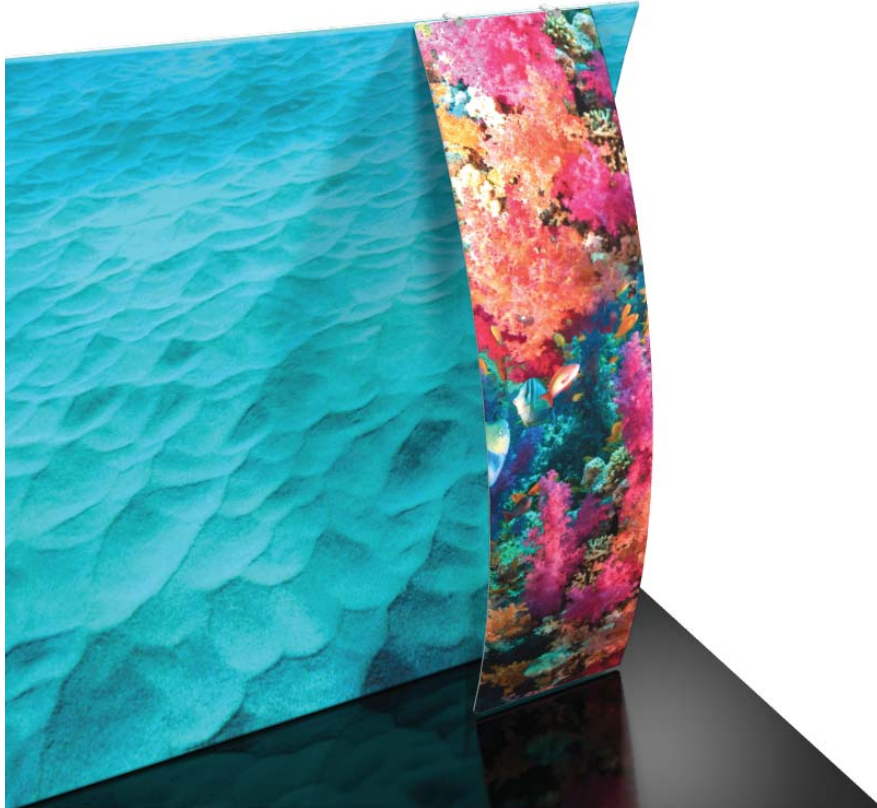

features and benefits:

- State-of-the-art 30mm aluminum tube frame with snap button assembly
- Easy to store and ship
- Quick to assemble and attach to frame
- Kit includes: one frame, one dye-sublimated zipper pillowcase graphic, and one wheeled molded OCL storage case
- Lifetime hardware warranty against manufacturer defects

dimensions:

Hardware

Assembled unit:
23.6" w x 92.7" h x 17.7" d
668mm(w) x 2355mm(h) x 450mm(d)

Approximate weight:
8 lbs / 3.6 kgs

Graphic

Refer to related graphic template for more information.

Visit:
www.exhibitors-handbook.com/graphic-templates

Shipping

Shipping dimensions:

1 OCL

57" l x 19" h x 19" d
1448mm(l) x 483mm(h) x 483mm(d)

Approximate total shipping weight:
29 lbs / 13 kgs

additional information:

Graphic material:
Dye-sublimation zipper pillowcase fabric

When included in a larger kit, a different packaging solution will be listed to accommodate all contents of the kit. Individual packaging no longer provided.

We are continually improving and modifying our product range and reserve the right to vary the specifications without prior notice. All dimensions and weights quoted are approximate and we accept no responsibility for variance. E&OE. See Graphic Templates for graphic bleed specifications.

Included In Your Kit

Tools, Components, Connectors & Tubes



HEX KEY 5MM x1



TCP-3030 x2



WL01-T1 x1



WL01-T2 x2



WL01-T3 x4

Graphics

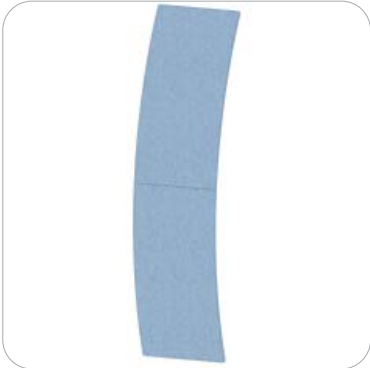

FMLT-WL01-G x1

Exploded View

FMLT-WL01-01

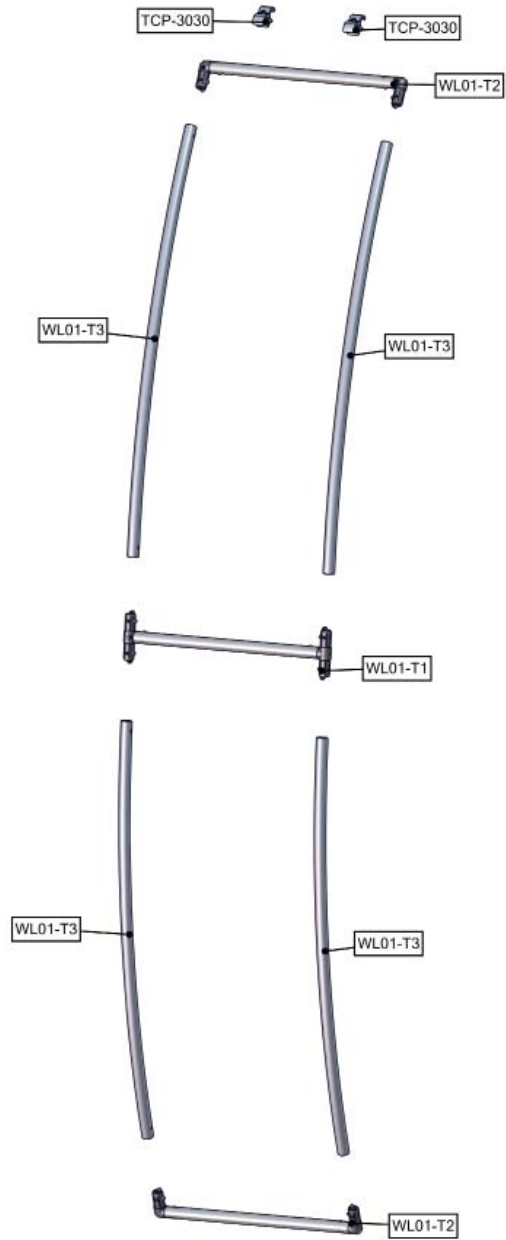

Labeling Diagram

FMLT-WL01-01

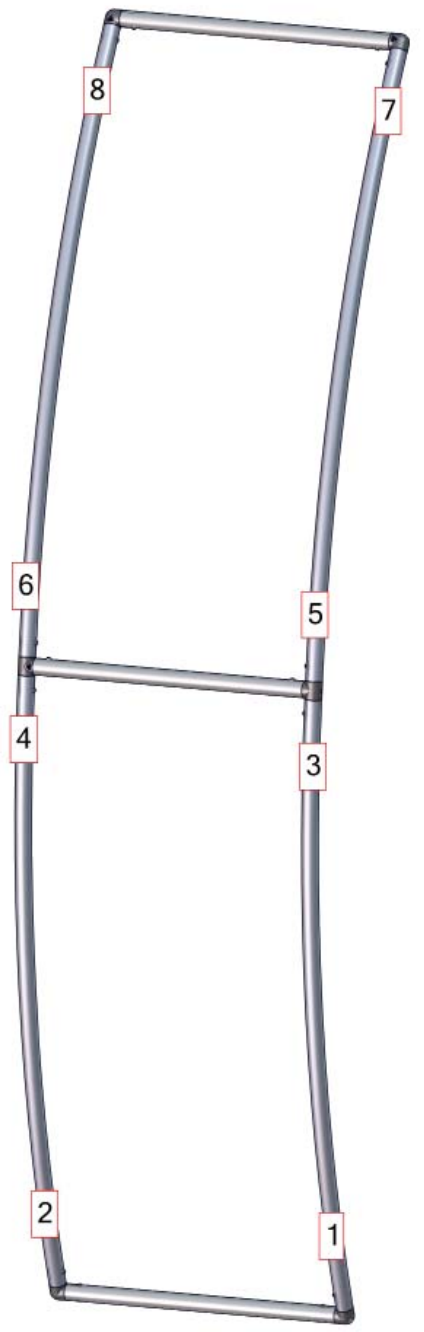

Connection Methods

Formulate® structures use a number of different yet simple connection methods. Your kit will include one or more of the connection methods shown below. Steps within the Kit Assembly will reference a specific method for each connection point.

Connection Method 1: ES30 / ES50 / ES75

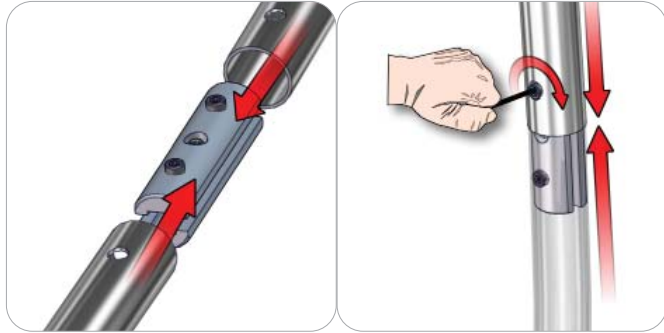

Compress the unlocked connector and slide one tube onto each end. Lock both screws carefully using your allen key tool. Be sure to lock securely, but do not overtighten.

Connection Method 2: Snap Buttons & Swage

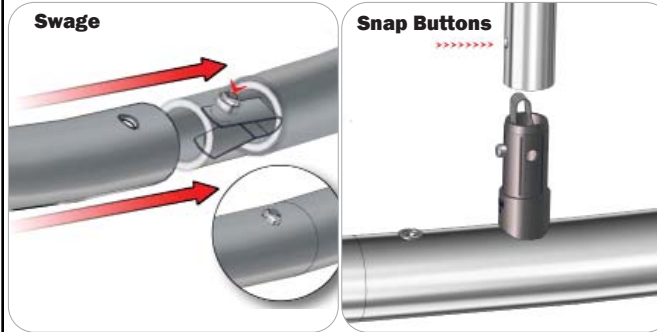

Locate the snap button on the connector or swage tube. Locate the hole on the corresponding tube. Press the snap button with your thumb and slide the tube and connector together so that the snap button snaps fully into the lock hole. To disassemble, press the snap button and pull apart.

Connection Method 3: ES30-90B / ES30-I / ES30-C

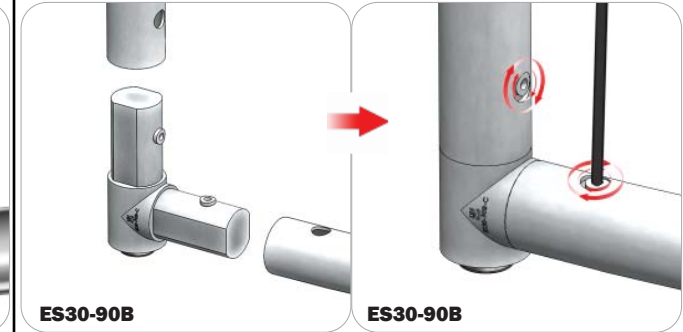

Compress one unlocked end of the connector and slide it through one tube end. Compress the other end of the connector and slide on the second tube. Lock both screws carefully using your allen key tool. Be sure to lock securely, but do not overtighten.

Connection Method 4: Tube Clamps

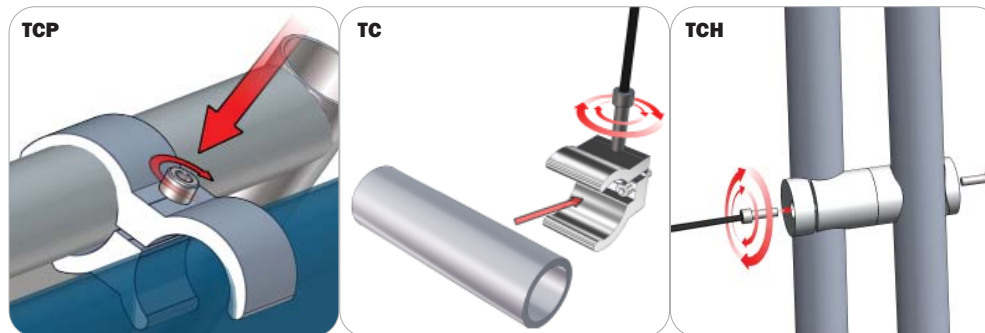

Be sure to fully assemble all frames before using clamps. With the clamp unlocked, place one tube of the first frame into the mouth of the clamp. Place the second tube (if applicable) into the second mouth of the clamp. With both frame's tubes in the clamp, be sure to lock securely, but do not overtighten.

Kit Assembly

Step by Step

Step 1.

Locate the components necessary for assembling the quick snap button frame. Assemble your frame in order according to the Labeling Diagram. Please reference Connection Method 2 for more details.

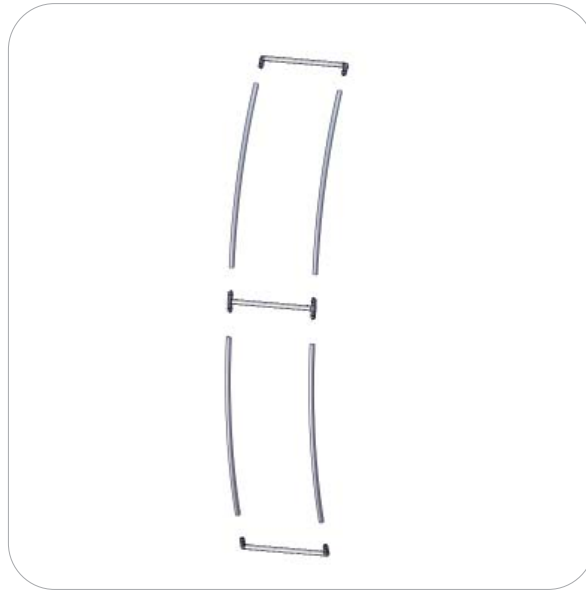

Step 2.

Apply the pillowcase graphic around the frame from the top and zip along the bottom edge. Using the handtool provided, attach the ladder onto your backwall. Please reference Connection Method 4 for more details.

