

X-Leg Counter

LN-CU-01

Dress up your space with sophisticated and functional counters. Counter tops are available in four thermoform finishes – silver, black, mahogany, and natural. Printed graphic panels create the base of the counter. Comes standard with a locking cabinet door. Custom counter top colors are available.







We are continually improving and modifying our product range and reserve the right to vary the specifications without prior notice. All dimensions and weights quoted are approximate and we accept no responsibility for variance. E&OE. See Graphic Templates for graphic bleed specifications.

features and benefits:

- Custom appearance
- Easy to assemble
- Table top available in four finishes
- Locking door
- Internal shelf
- Installation tool included
- Aluminum frame construction
- Custom top and graphic colors available
- Legs can turn 90° for a different look
- Lifetime limited hardware warranty against manufacturer defects

dimensions:

Hardware	Graphic
<p>Assembled Unit: 45.9" w x 39.2" h x 21.2" d 1166mm(w) x 996mm(h) x 538mm(d)</p> <p>Interior Cabinet Dimensions: 22" w x 38" h x 12" d 559mm(w) x 965mm(h) x 305mm(d)</p> <p>Tabletop Dimensions: 45.9" w x 1" h x 21.2" d 1166mm(w) x 25mm(h) x 538mm(d)</p>	<p>Refer to related graphic template for more information.</p> <p>Visit exhibitors-handbook.com/graphic-templates</p>
Shipping	
<p>Packing case(s): 1 OCH2</p> <p>Shipping dimensions: 52" l x 29" h x 15" d 1321mm(l) x 737mm(h) x 381mm(d)</p> <p>Approximate total shipping weight (includes cases & graphics): 80 lbs / 37 kgs</p>	
<h2>additional information:</h2> <p>Graphic material: UV - 6mm Sintra</p> <p>Counter holds max 20 lbs / 9 kgs</p> <p>Tabletop Colors</p> <div style="display: flex; justify-content: space-around; align-items: center;"> <div style="text-align: center;">  silver </div> <div style="text-align: center;">  black </div> <div style="text-align: center;">  mahogany </div> <div style="text-align: center;">  natural </div> </div>	

Included In Your Kit

Tools, Components, Connectors, & Extrusions



5mm ALLEN KEY x1



PH-280-S-S x4



V-CAB-01-DR x1



V-CAB-01-FR x1



SS1-S x4



V-CU-CT-01 x1

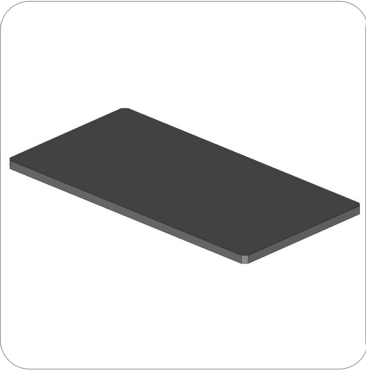

V-CU-CAB-01-S x1



V-LG-01 x1

Graphics

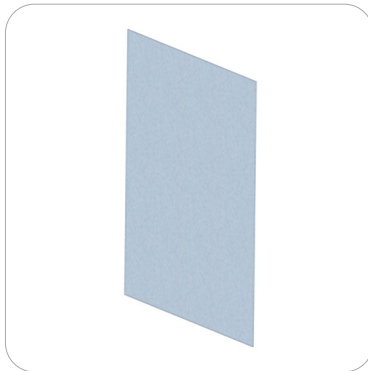

V-CAB-01-GF-FR-01 x1



V-CAB-01-GF-SD x2

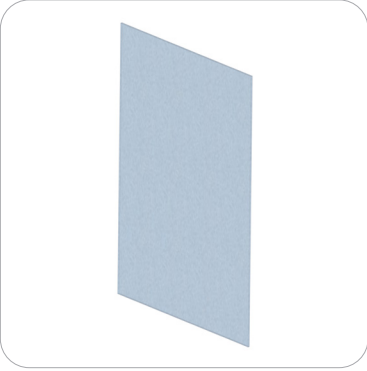

V-CAB-01-GF-DR x1

Exploded View

LN-CU-01

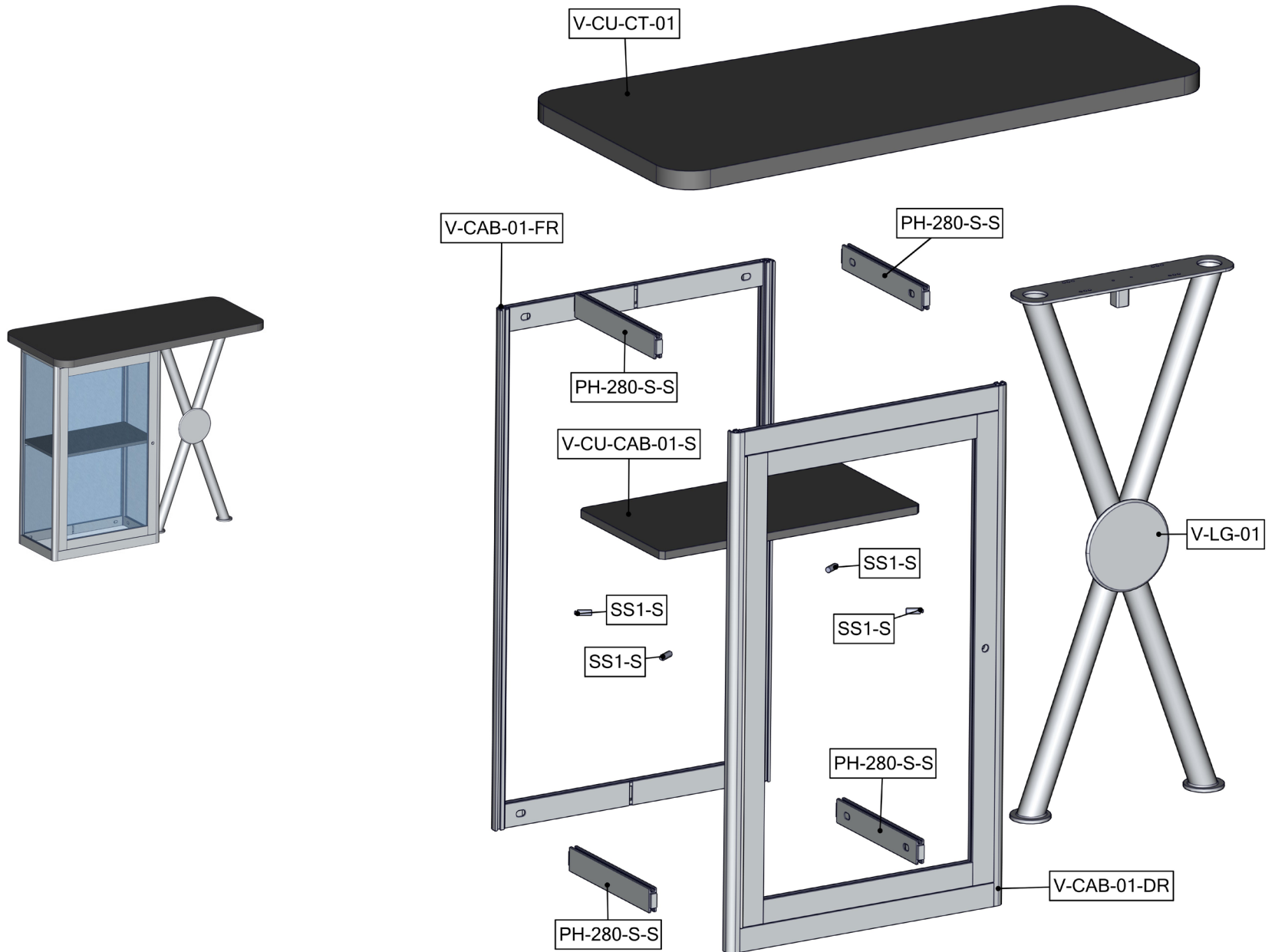

Connection Methods

Extrusion based structures use a number of different yet simple connection methods. Your kit will include one or more of the connection methods shown below. Steps within the Kit Assembly will reference a specific method for each connection point.

Connection Method 1: Cam Lock / Slide Lock

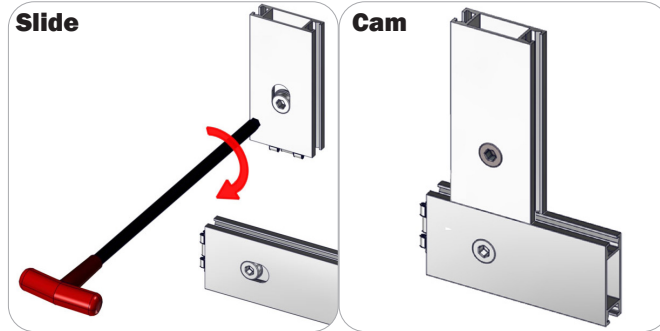

A cam lock equipped extrusion can lock to any cam lock channel. With the cam lock unlocked, set the teeth of the cam lock into the desired position on the cam lock channel. Using your allen key tool, carefully turn the lock clockwise to lock in place. Be sure to lock securely, but do not overtighten.

A slide lock equipped extrusion can also lock into any cam lock channel. When the slide lock is unlocked, pull back on the hex bolt head to retract the slide lock into the body of the extrusion. Slide locking procedure is the same as a cam lock.

Connection Method 2: IB2 / Corner Brackets

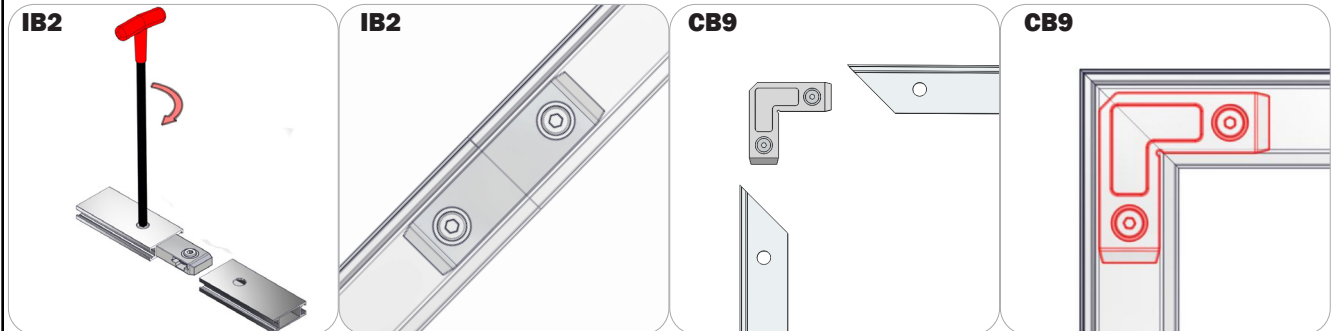

Press the hex bolt head in with your thumb and slide the extrusion and connector together so that the hex bolt head sits into the lock hole. Repeat with the second extrusion to the free end of the connector. Lock the extrusions together by turning carefully with the allen key tool. Be sure to lock securely, but do not overtighten.

Connection Method 3: SW-FOOT

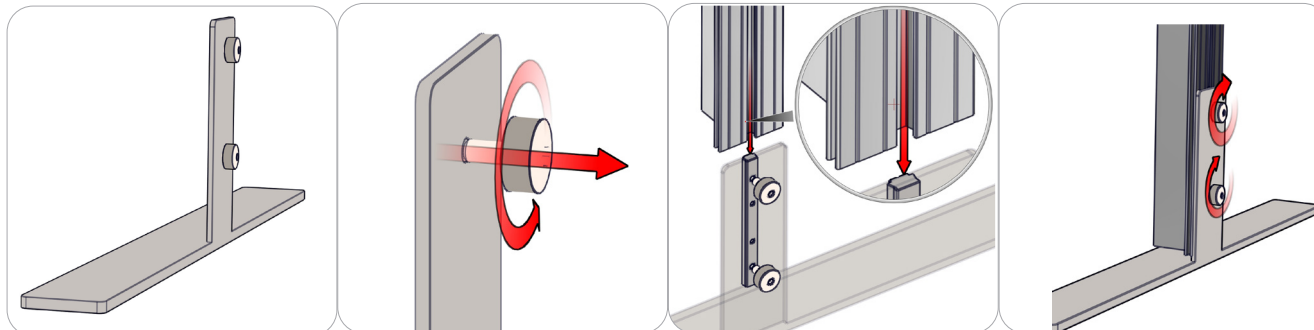

An SW-FOOT assembly consists of two thumb screws, an LN100, and SW-FOOT baseplate. Start by loosening the thumb screws (it is best not to completely remove the screws). Slide the extrusion onto the LN100 by utilizing its back cam channel. When the extrusion rests on baseplate or ground (depending on application), tighten the thumb screws to lock in place. Do not overtighten.

Kit Assembly

Step by Step

Step 1.

Locate your V-CAB-01-DR and V-CAB-01-FR assemblies. Both frames should have preinstalled graphics. V-CAB-01-DR should also have a locking door, test to ensure it is properly functioning.

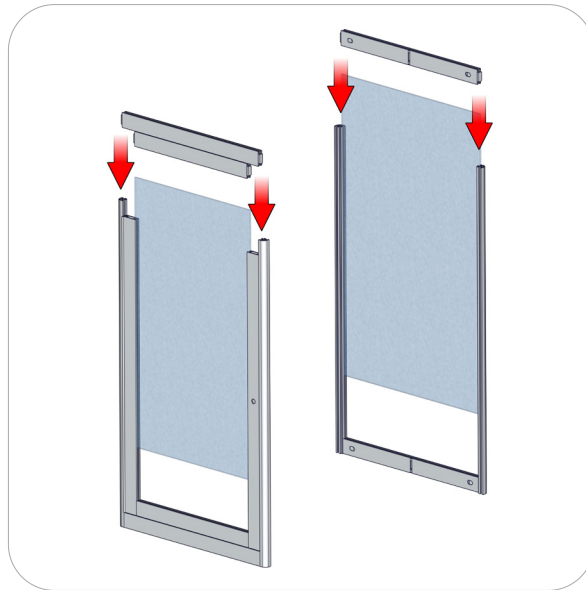
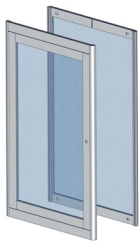

Step 2.

Locate (2) PH-280-S-S extrusions. Lock into place so that the hex bolt heads face inward to the cabinet and the extrusion is flush with the V-CAB-01-DR and V-CAB-01-FR.

Please reference Connection Methods 1 & 2 for more details.

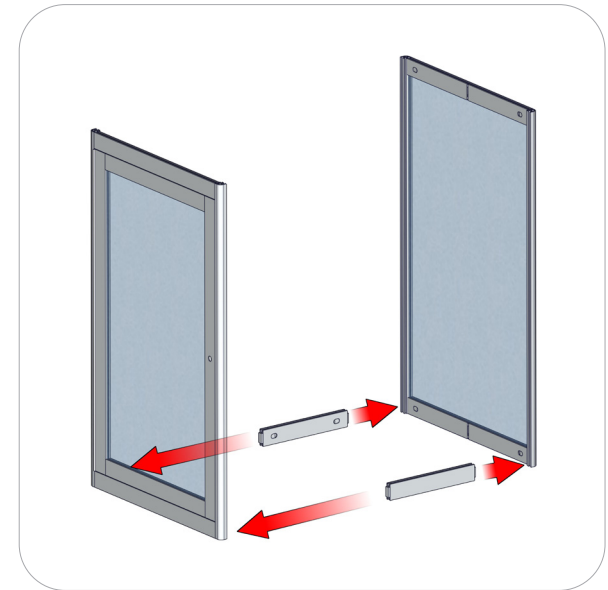

Step 3.

Locate (2) PH-280-S-S extrusions and cabinet side graphic panels. Slide your graphic into the channels of V-CAB-01-FR and V-CAB-01-DR. Next, lock your PH-280-S-S extrusions above the graphics.

Please reference Connection Methods 1 & 2 for more details.

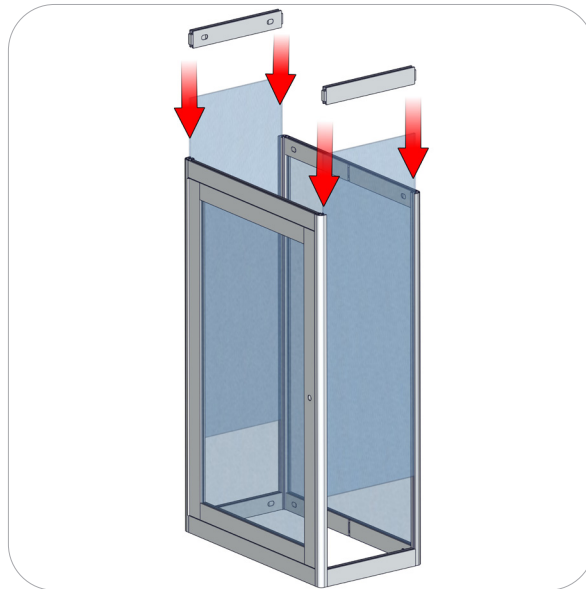
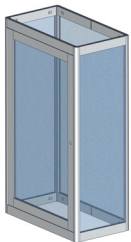

Step 4.

Locate your V-LG-01 and V-CU-CT-01 counter top. Note the imprinted placement templates on the underside of your countertop. Match the V-LG-01 with the counter top in the desired orientation. Lock your V-LG-01 to the counter top with the provided fastening hardware.

